

Turbo Storm ROLLER COASTER

This model is constructed with Rippin' Rocket Roller Coaster parts.

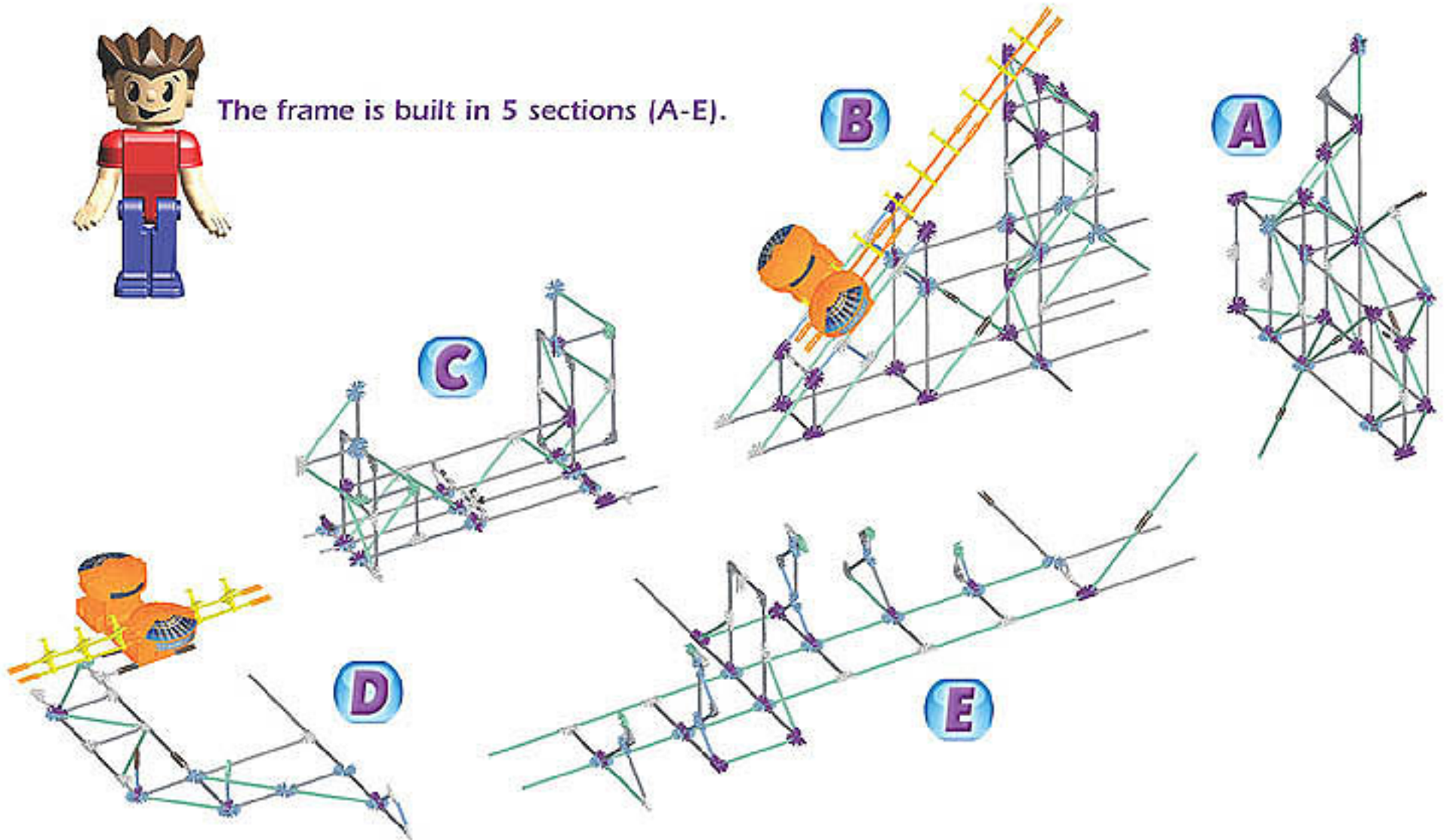

The frame is built in 5 sections (A-E).



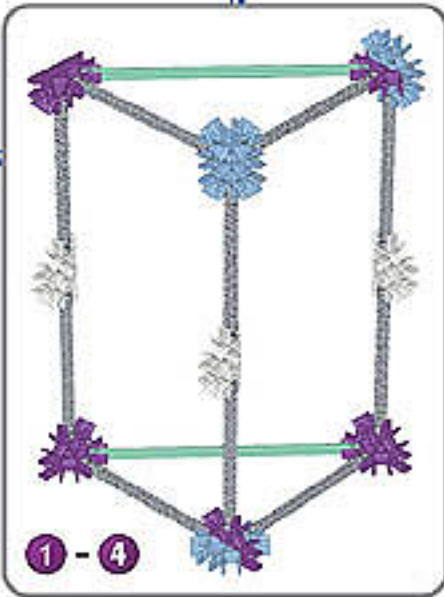
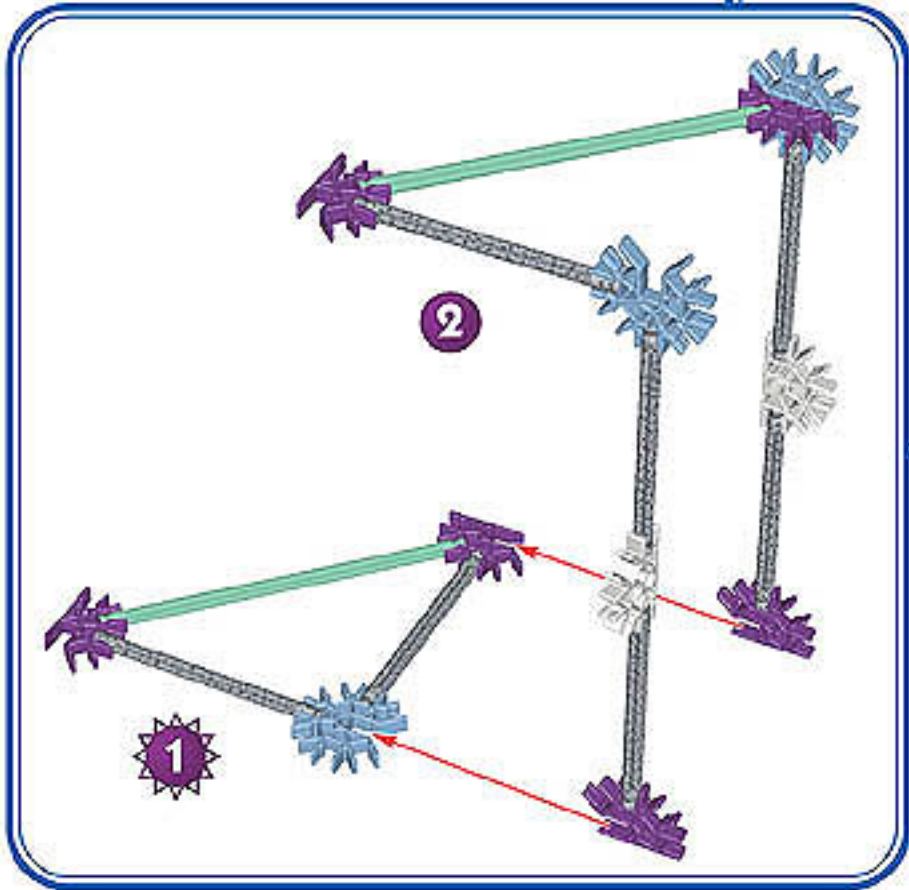
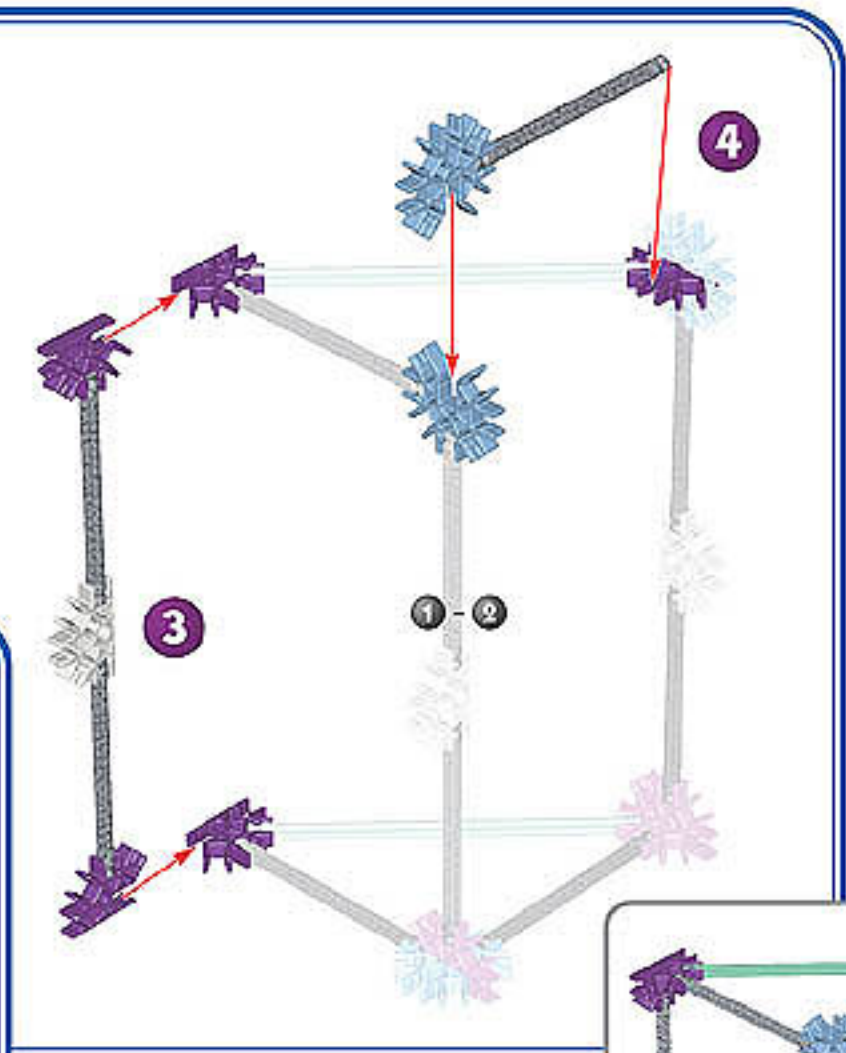
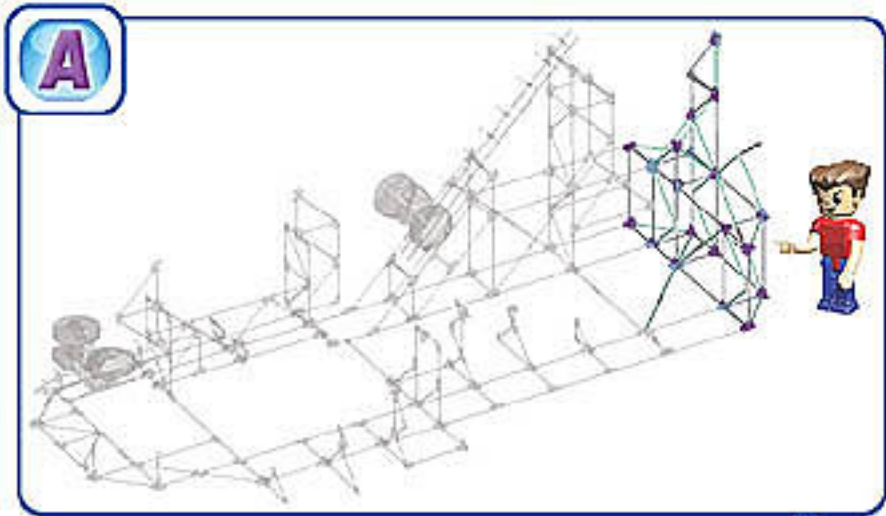

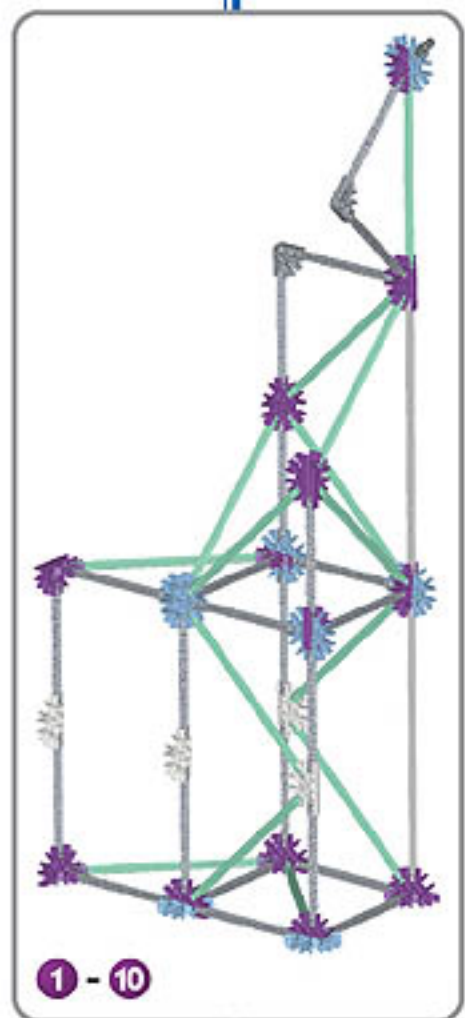
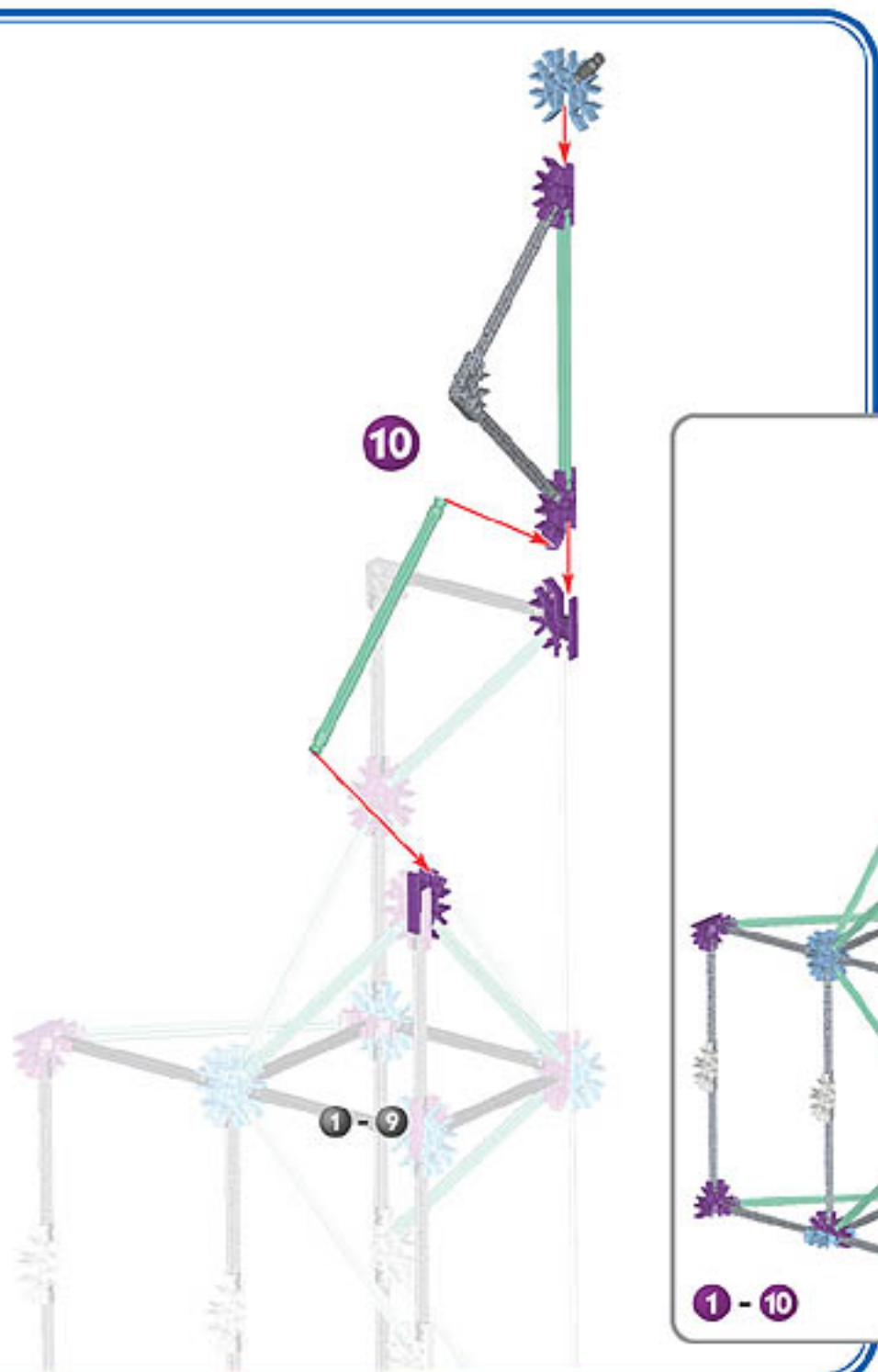
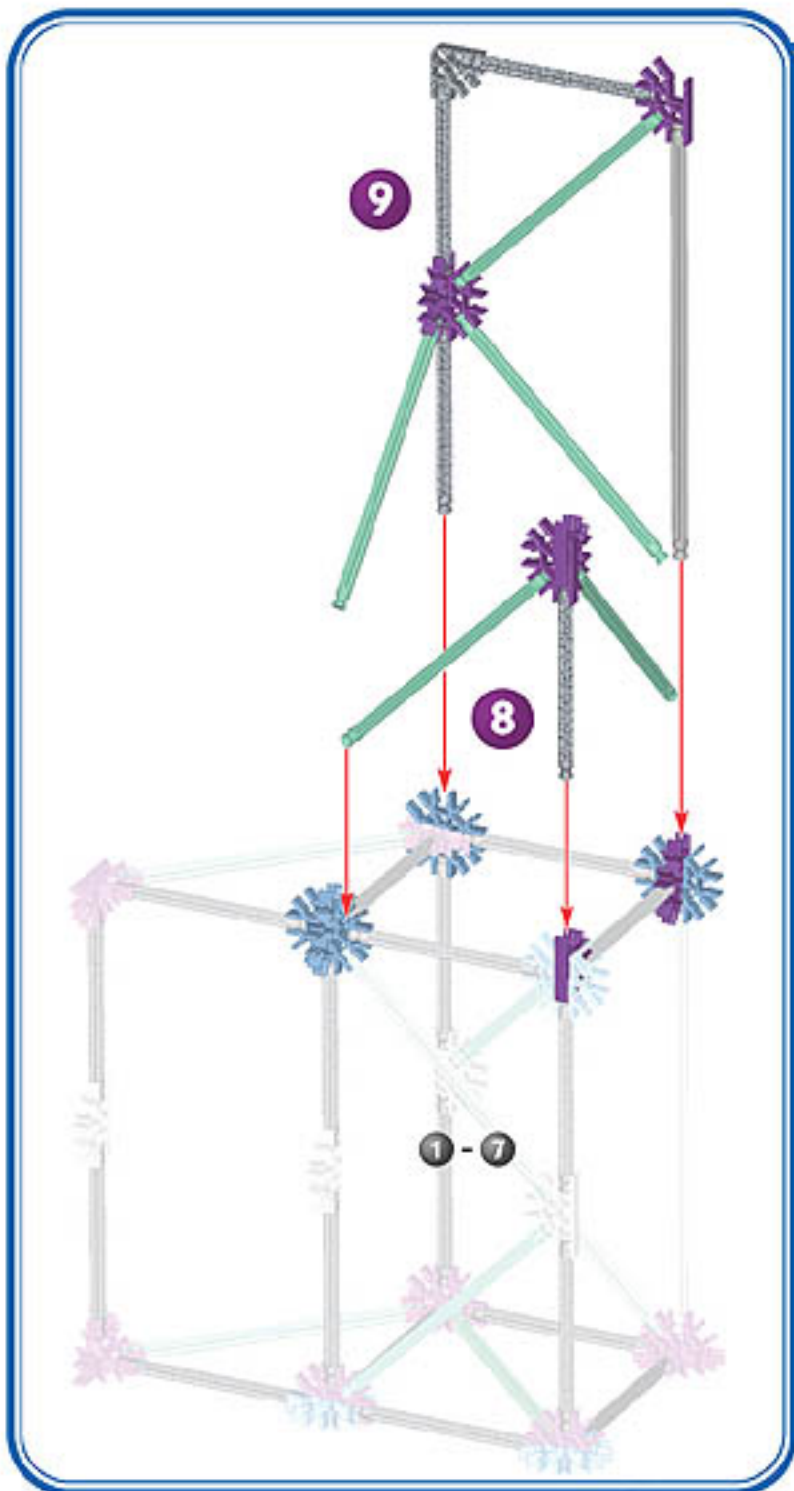

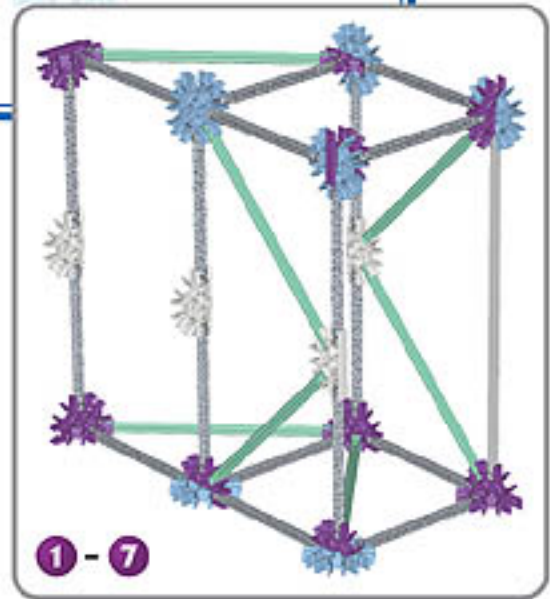
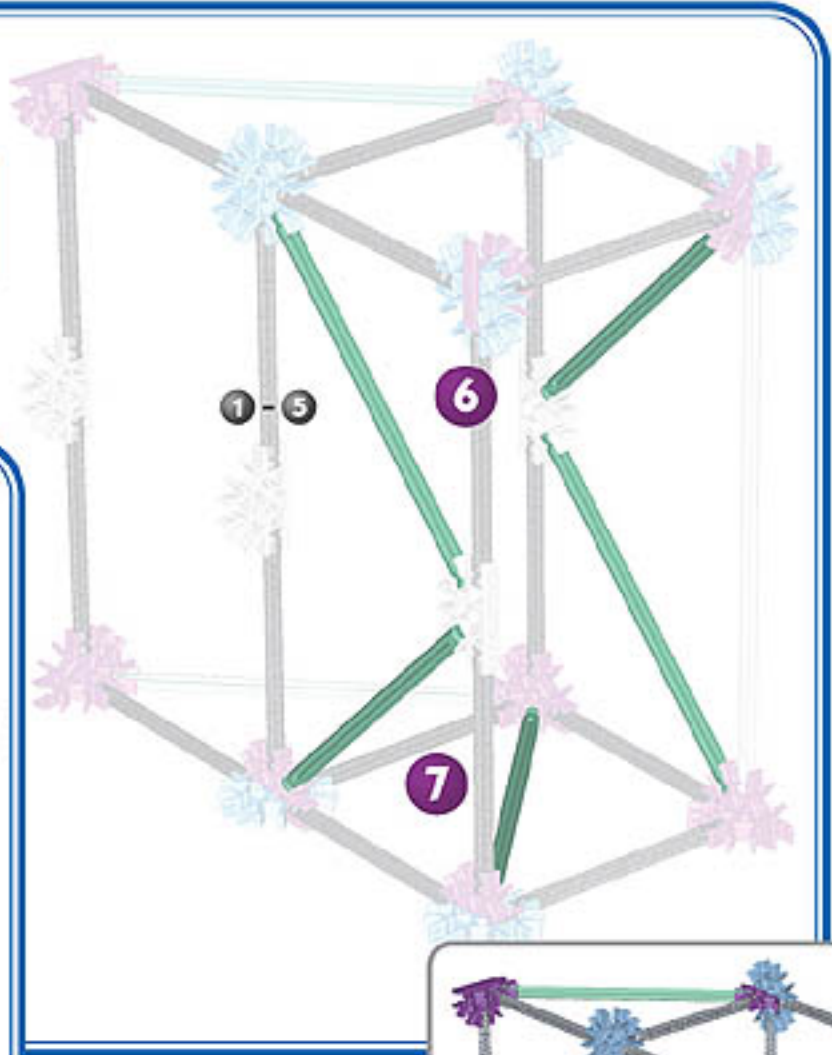
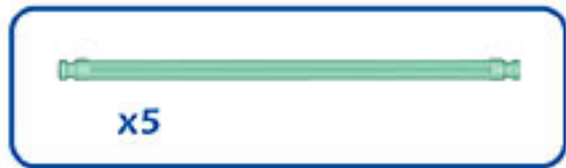
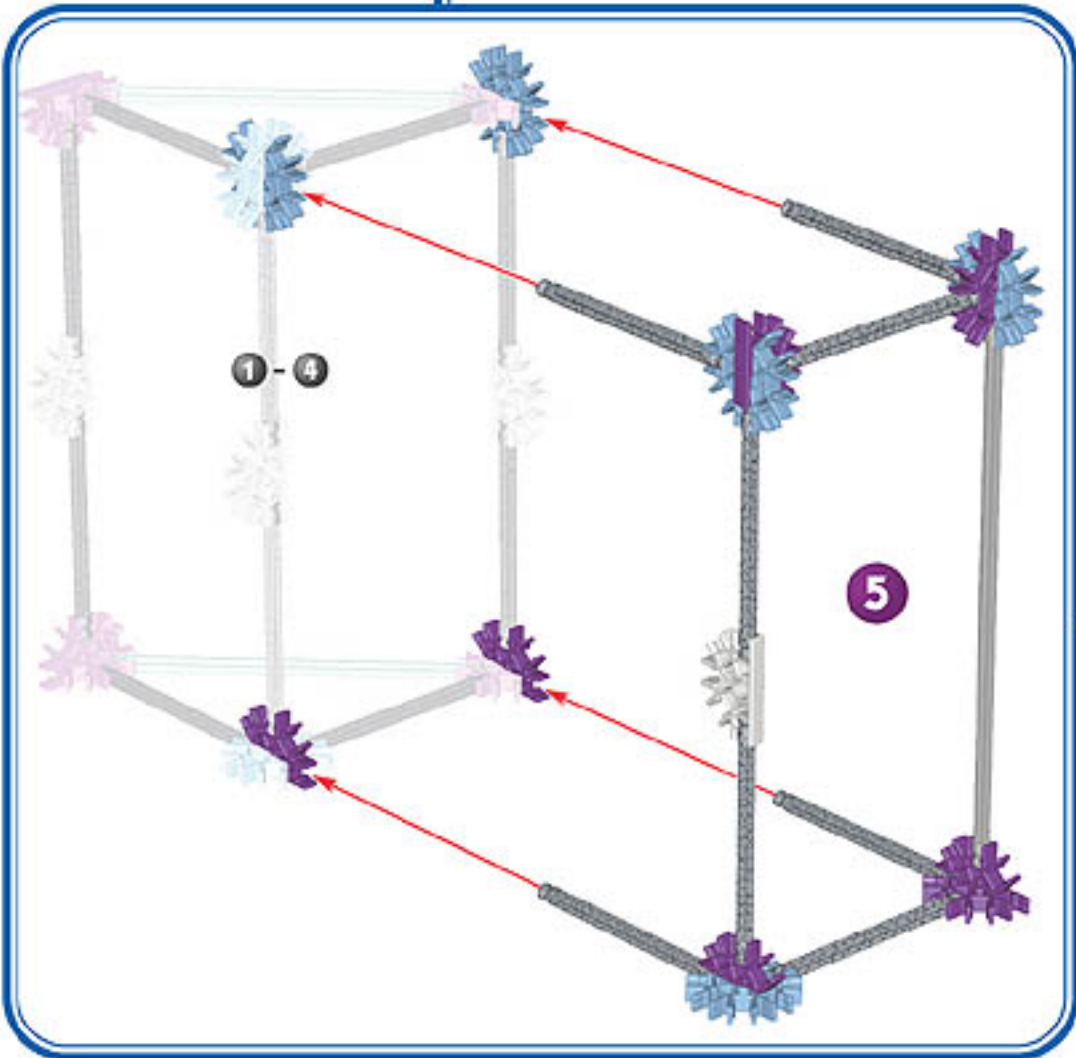

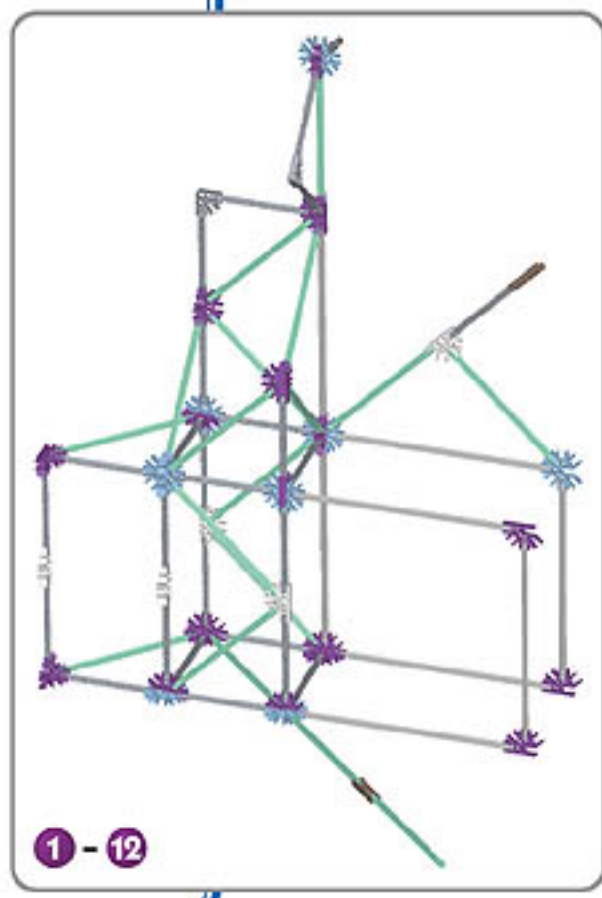
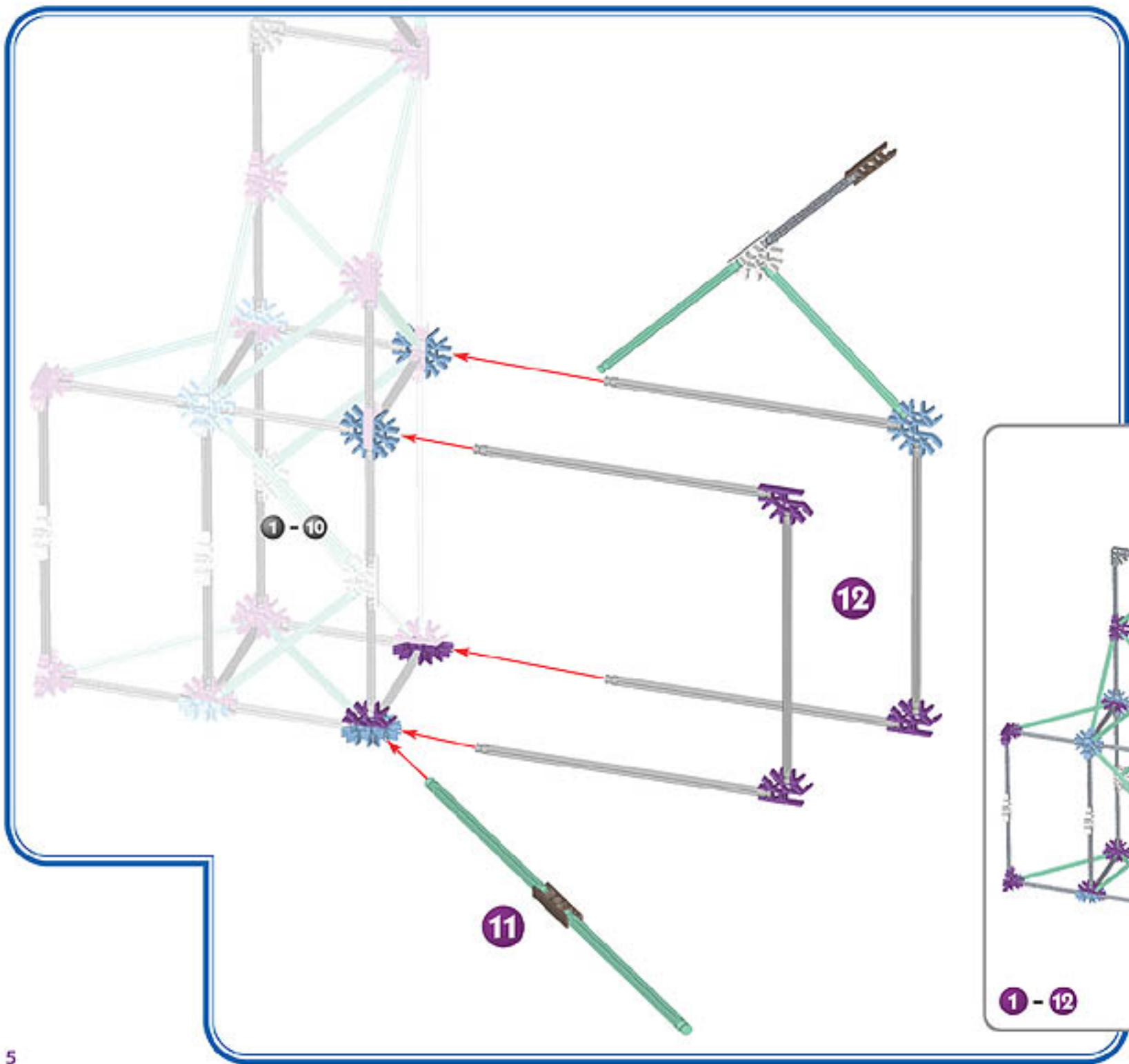

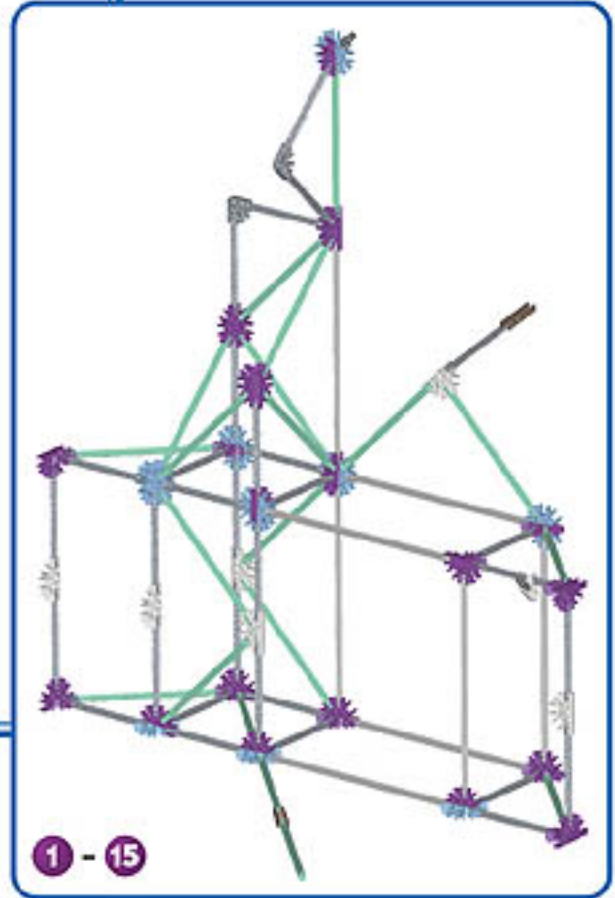
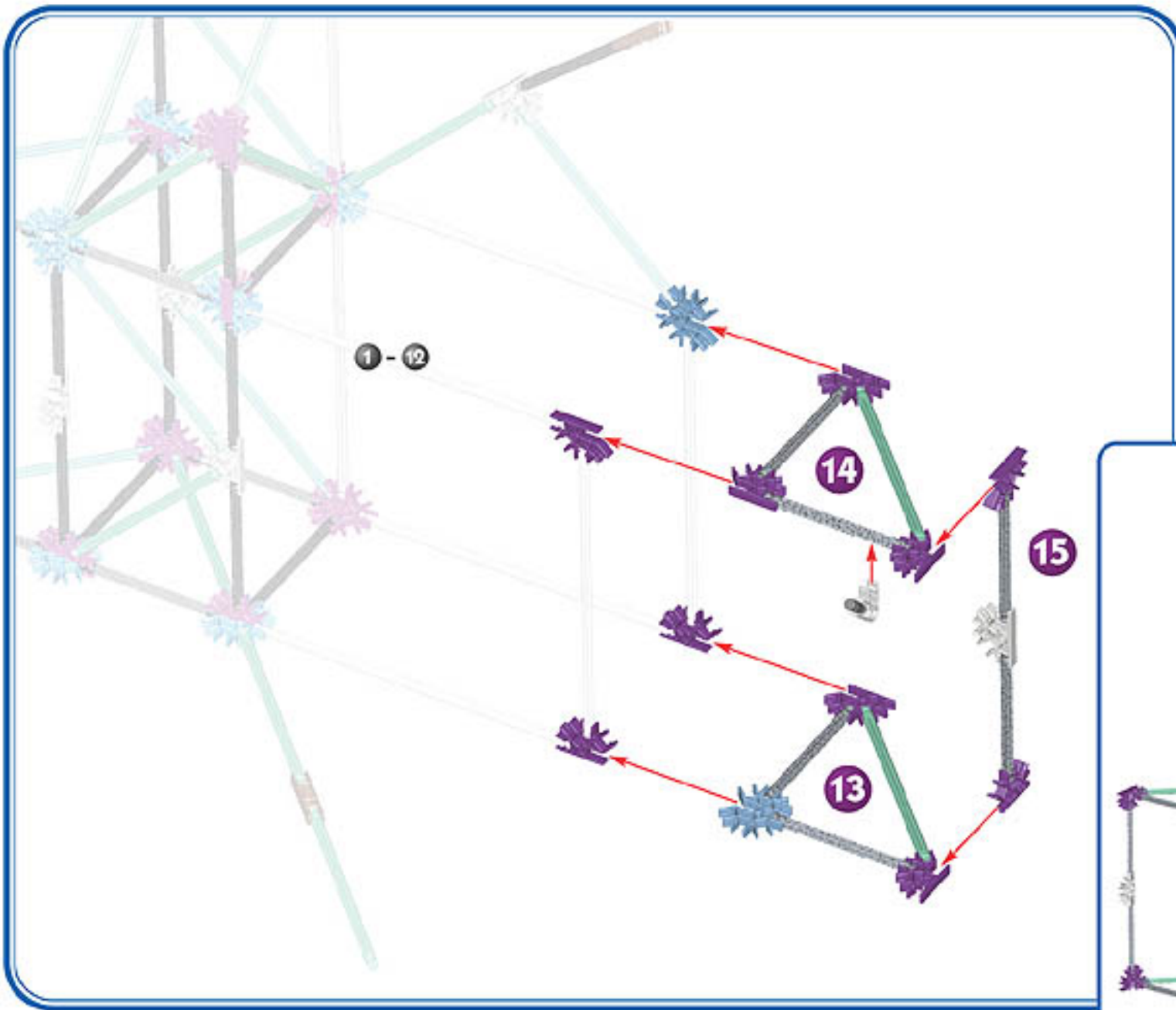

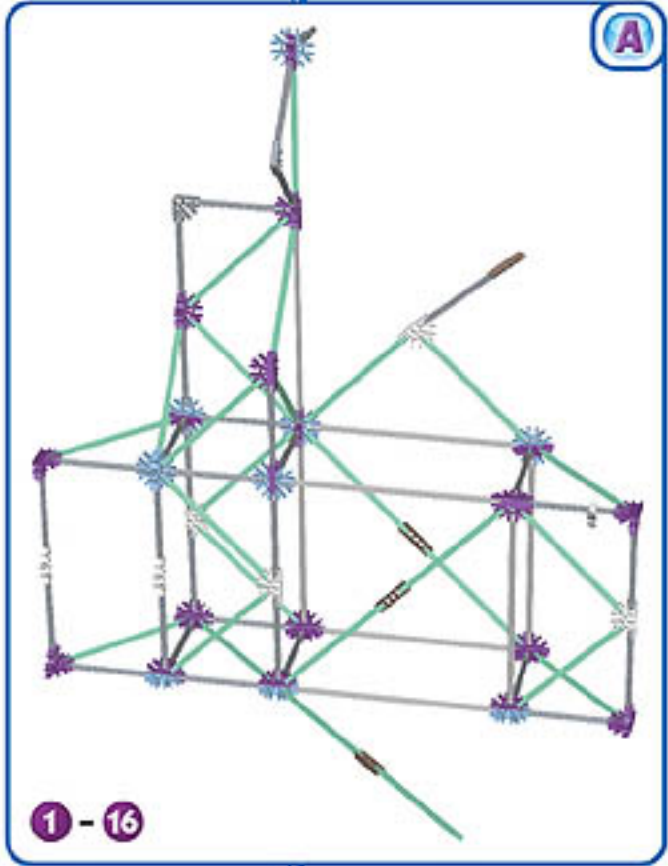
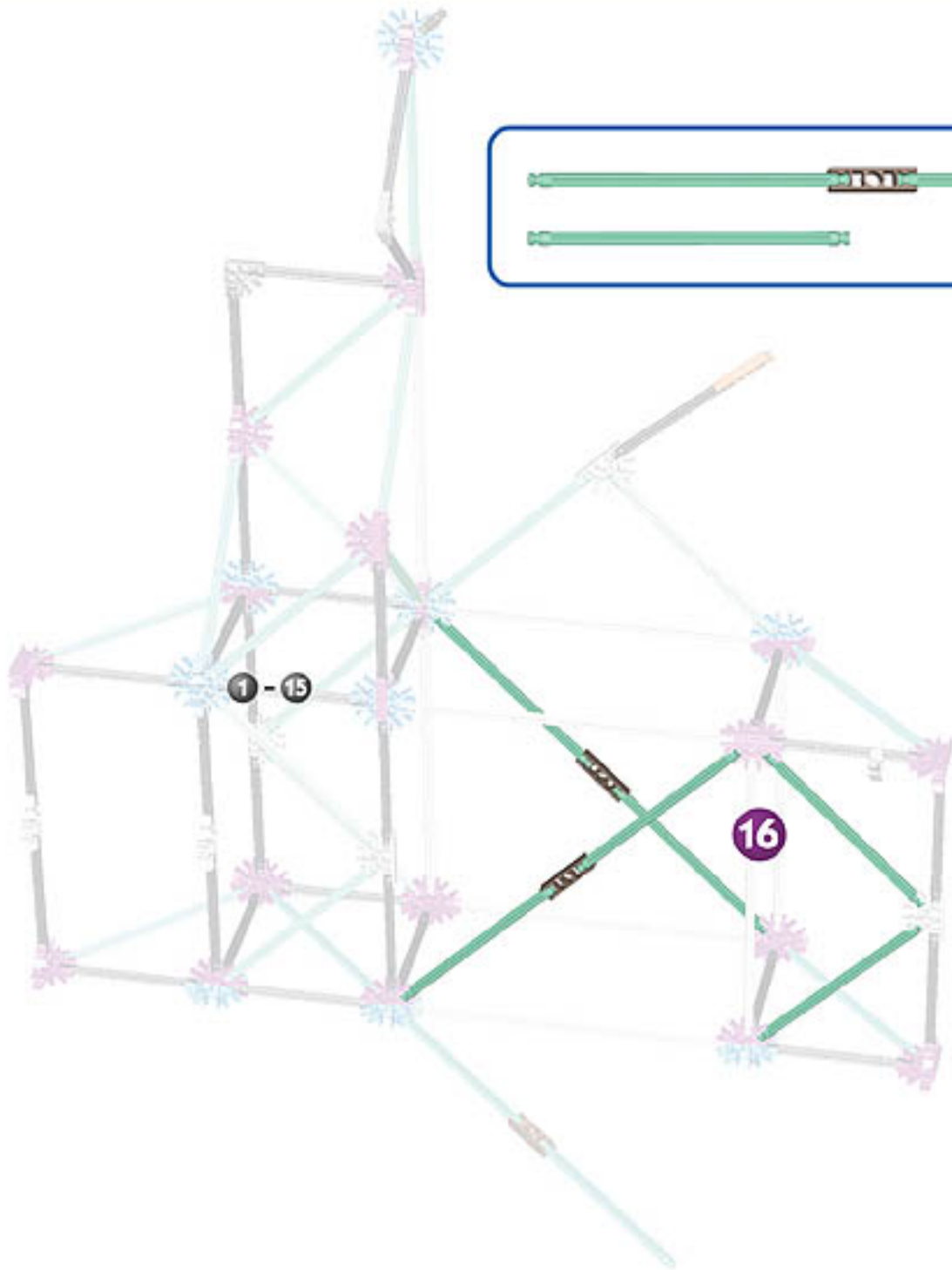
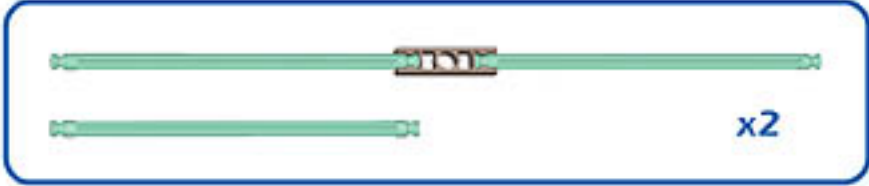

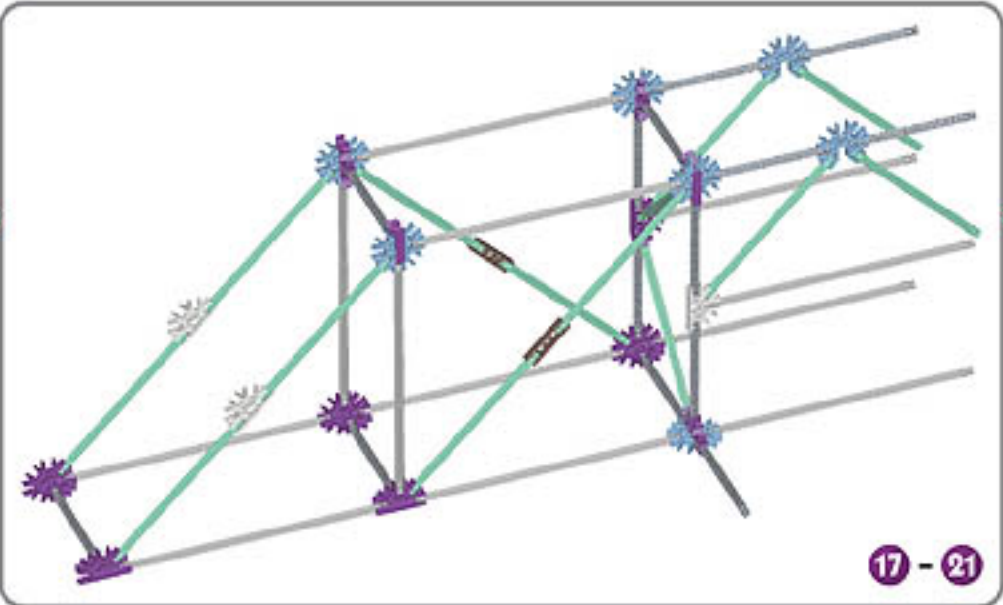
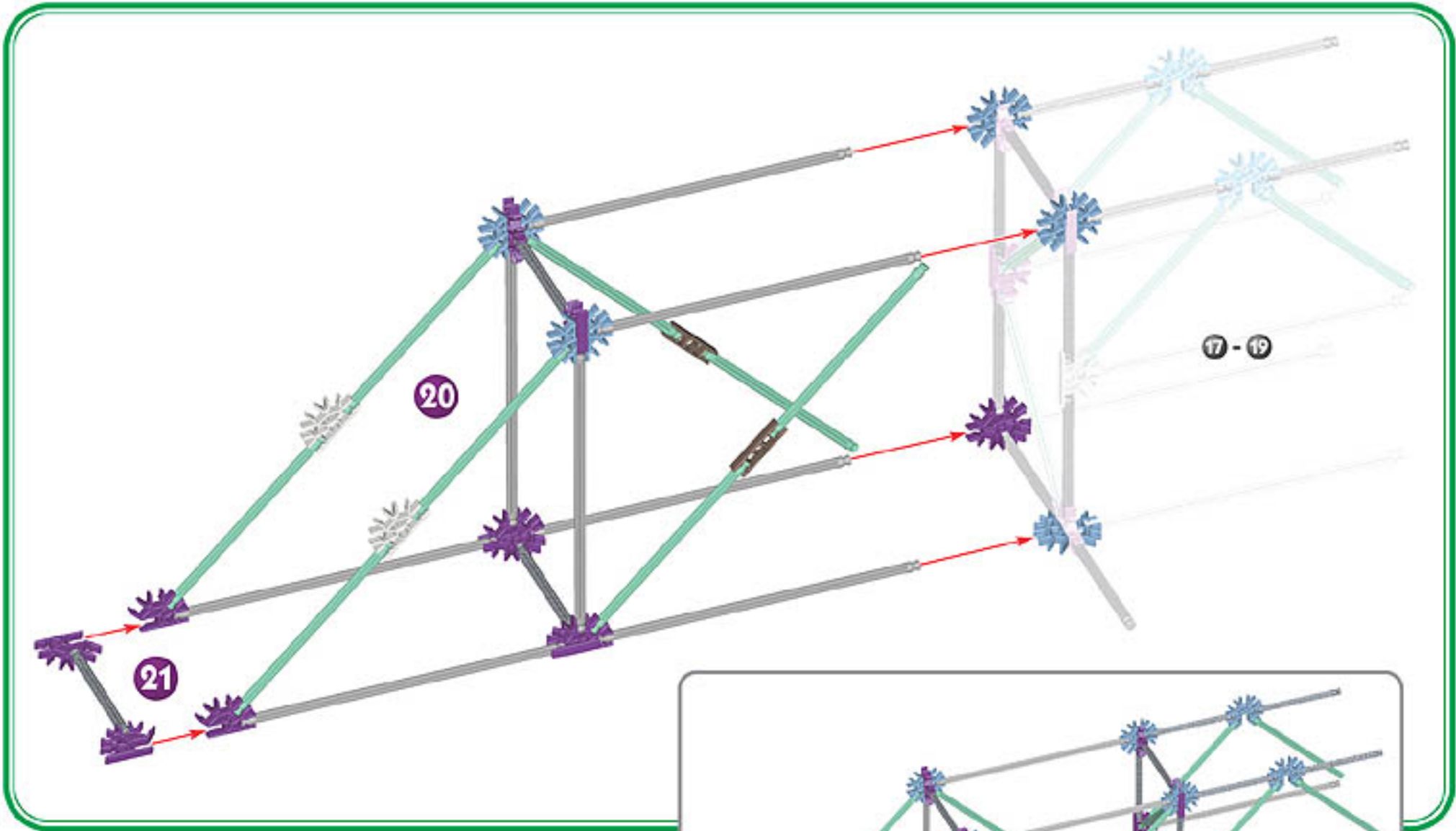

B

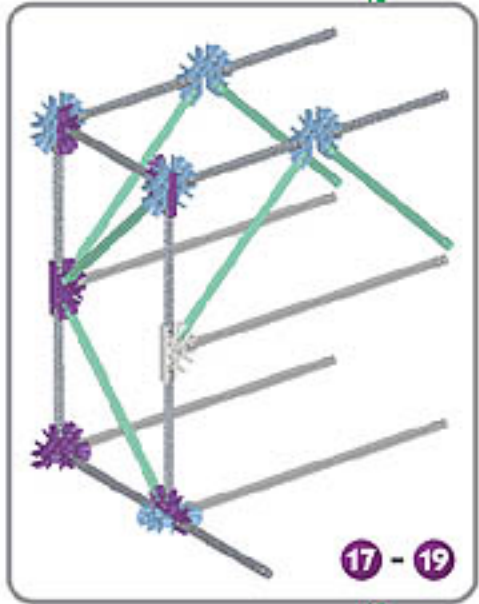
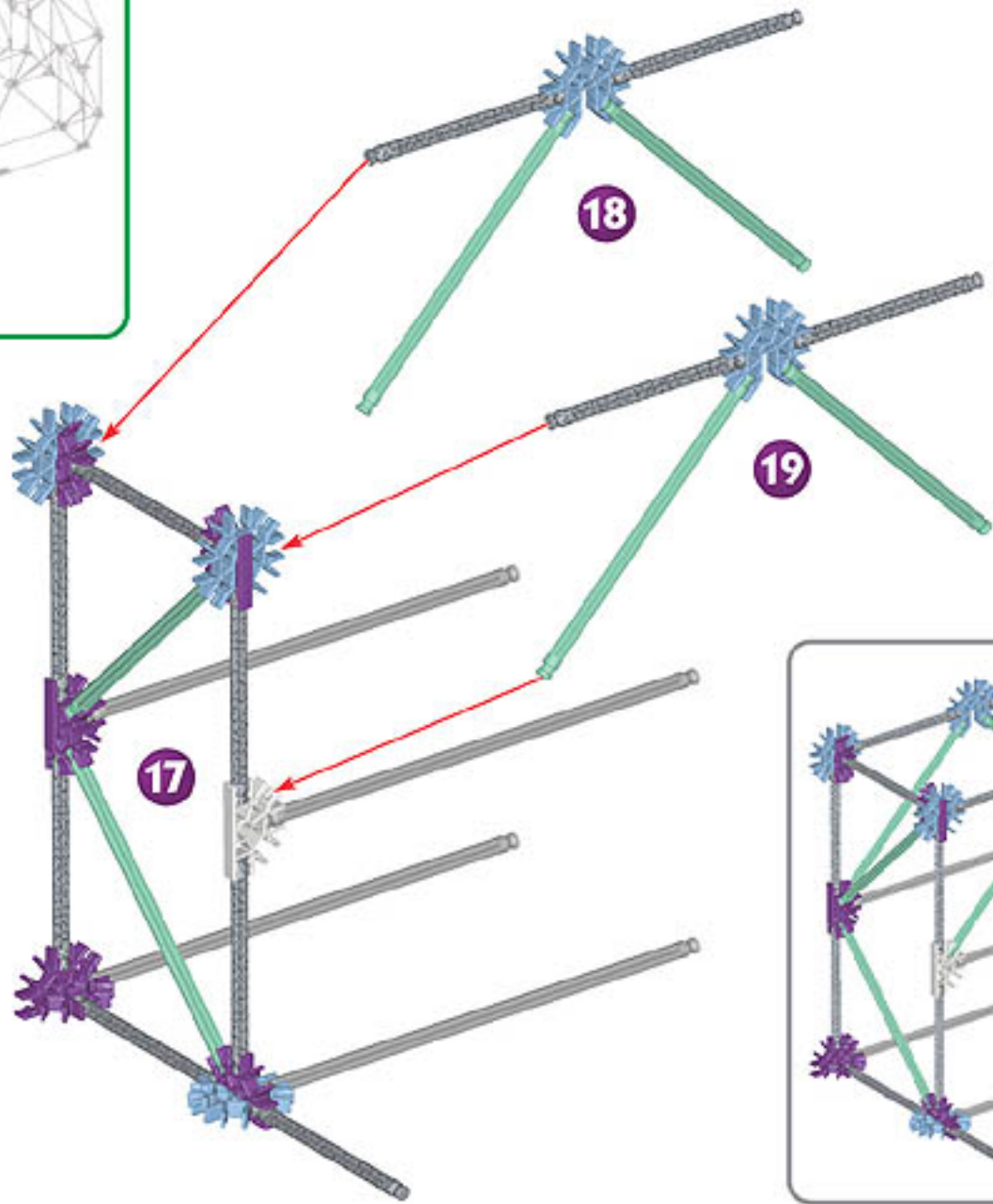
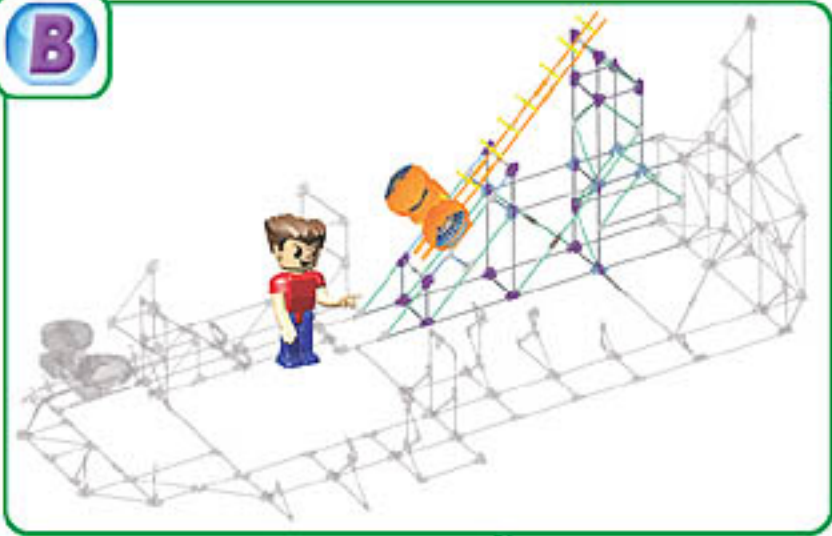

Install all batteries in the Turbo Booster before building.

Arrow on Turbo Booster must point up.

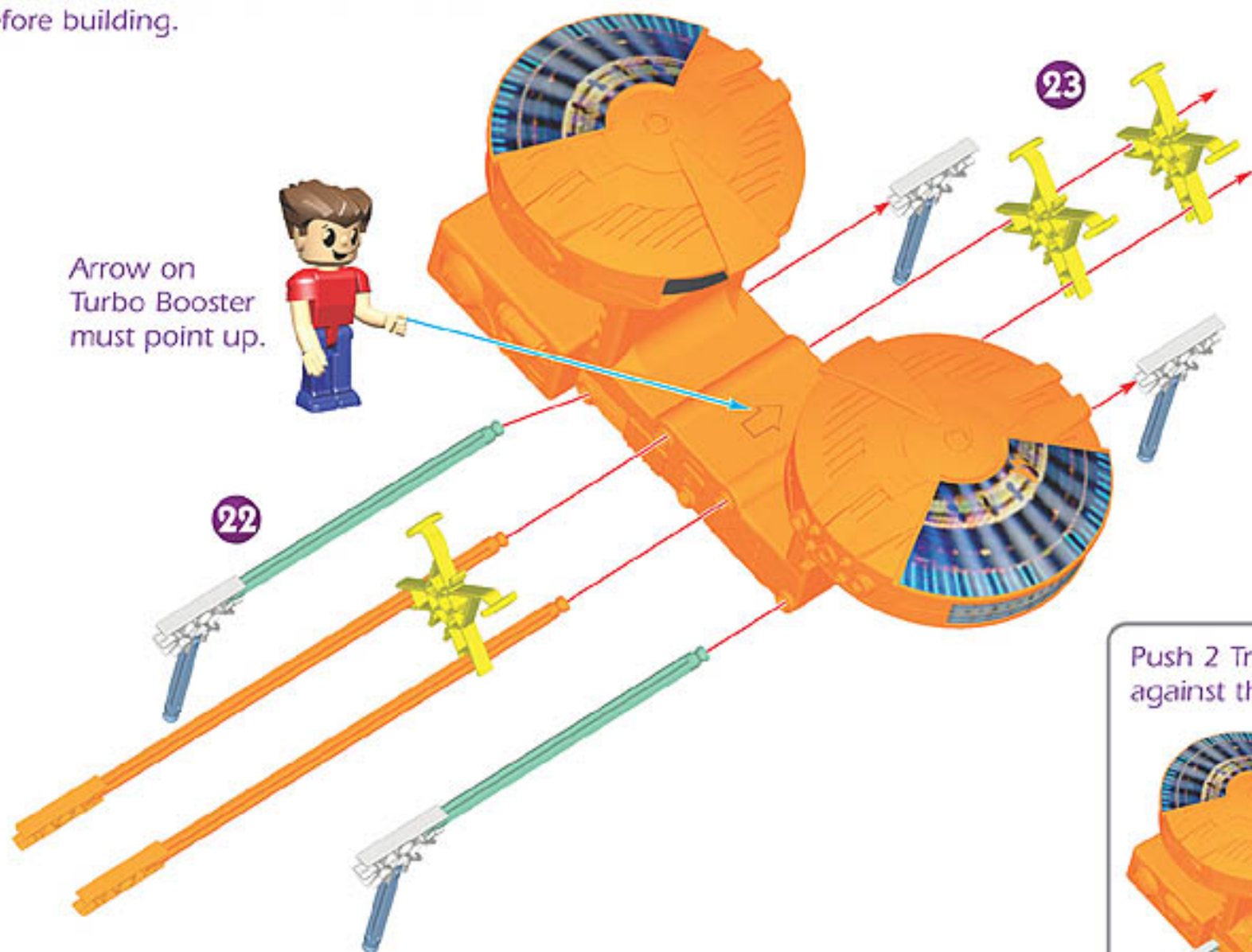

Push 2 Track Connectors against the Turbo Booster.



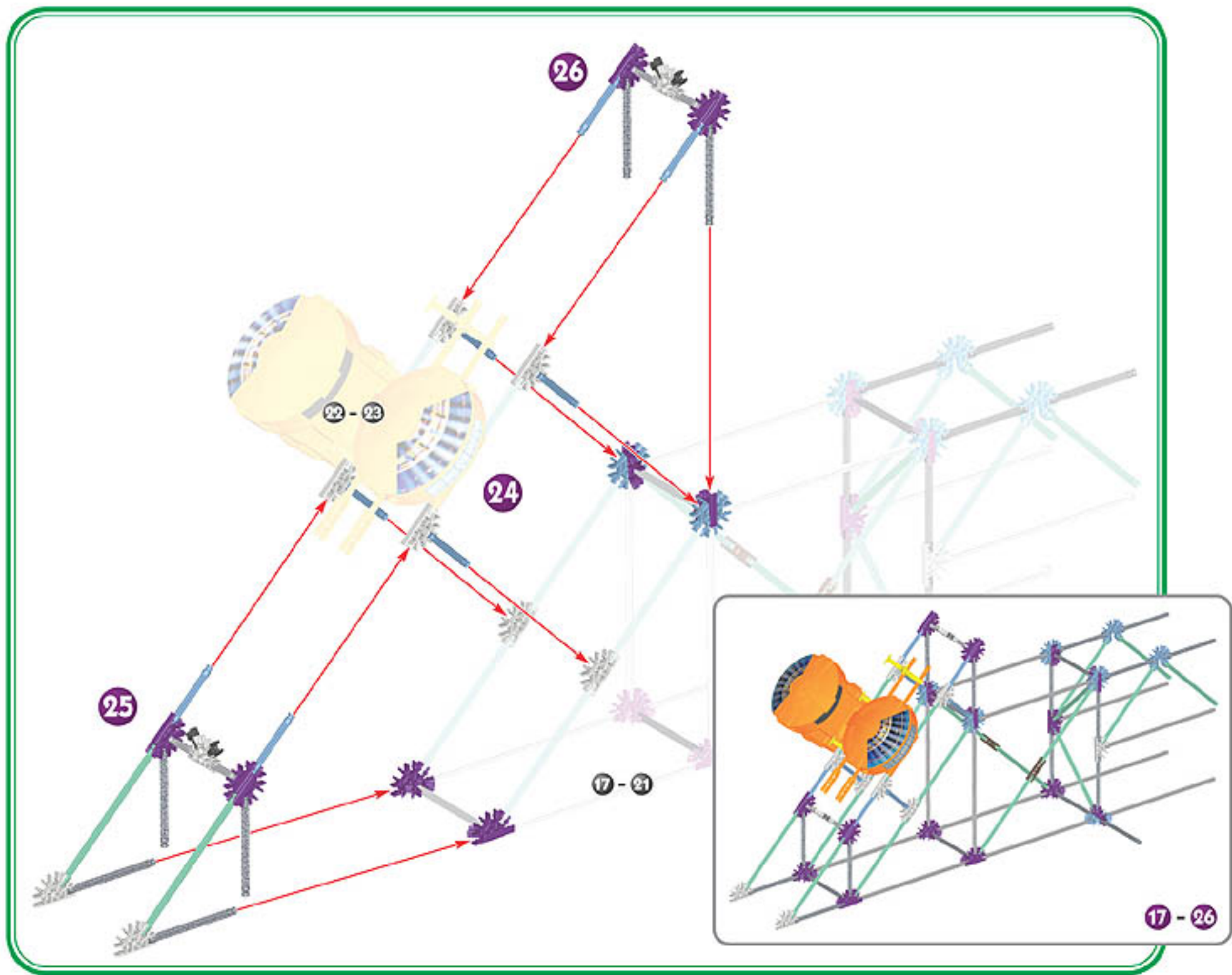

Number of
Track Connectors



x6

29

28

27

17 - 26

17 - 29

C

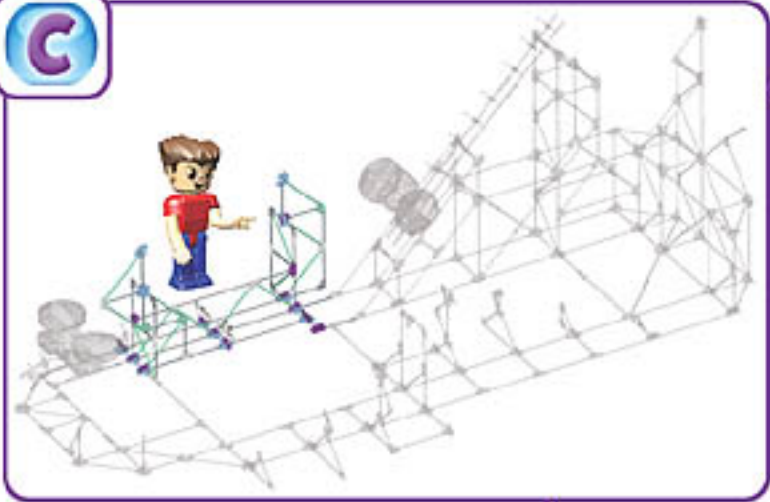

31

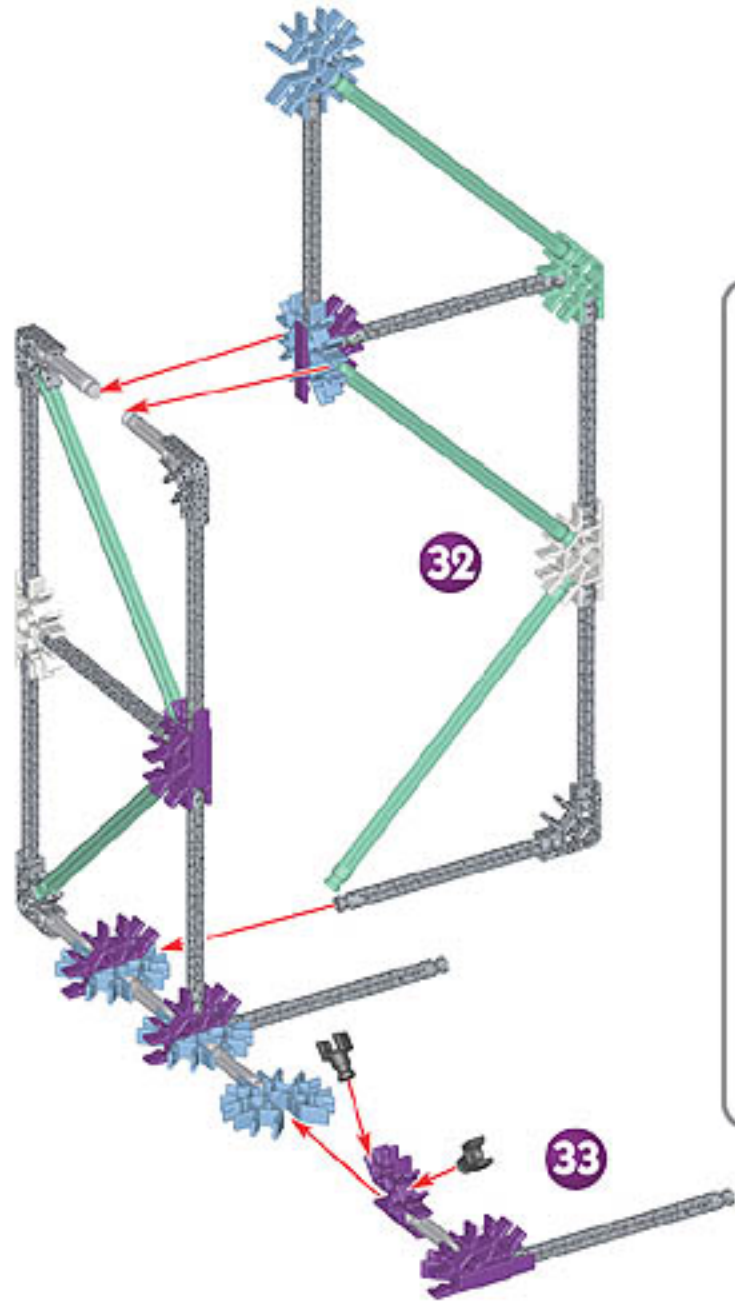

32

33

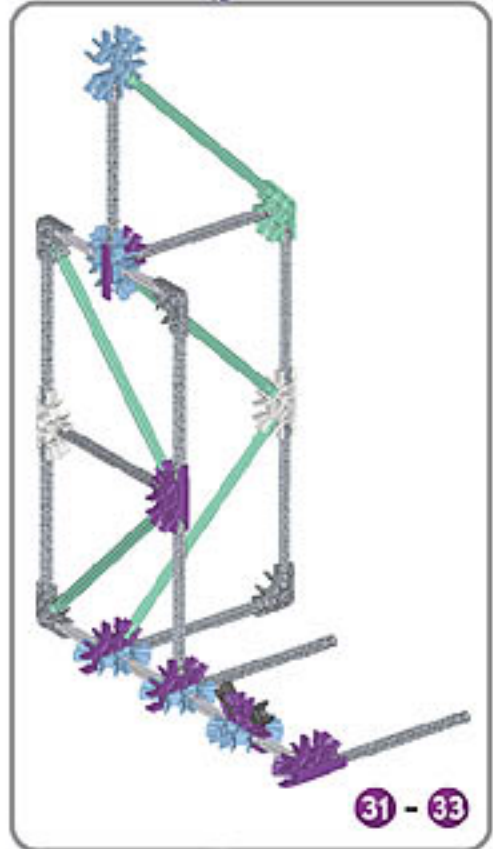

31 - 33

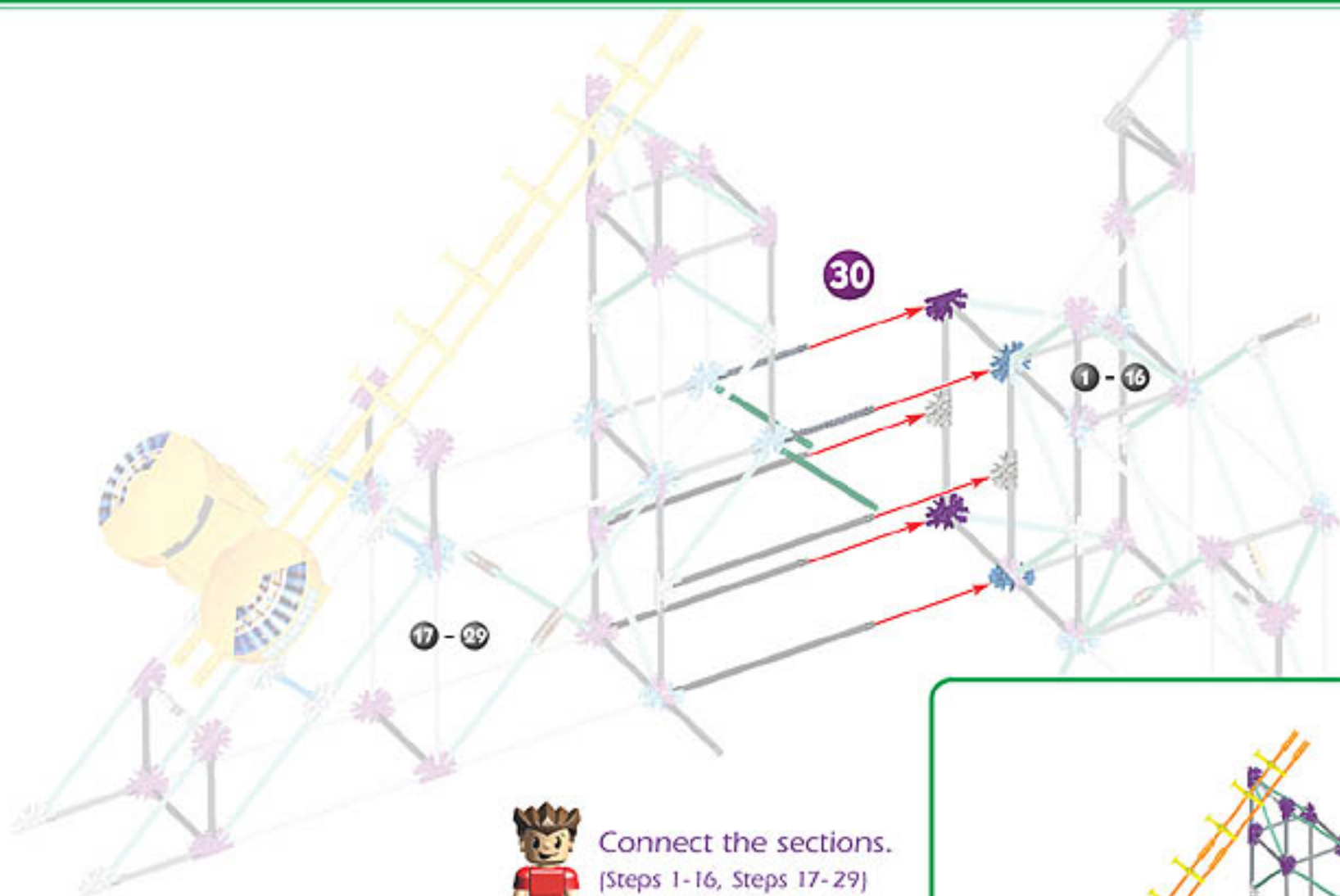

Connect the sections.
(Steps 1-16, Steps 17-29)

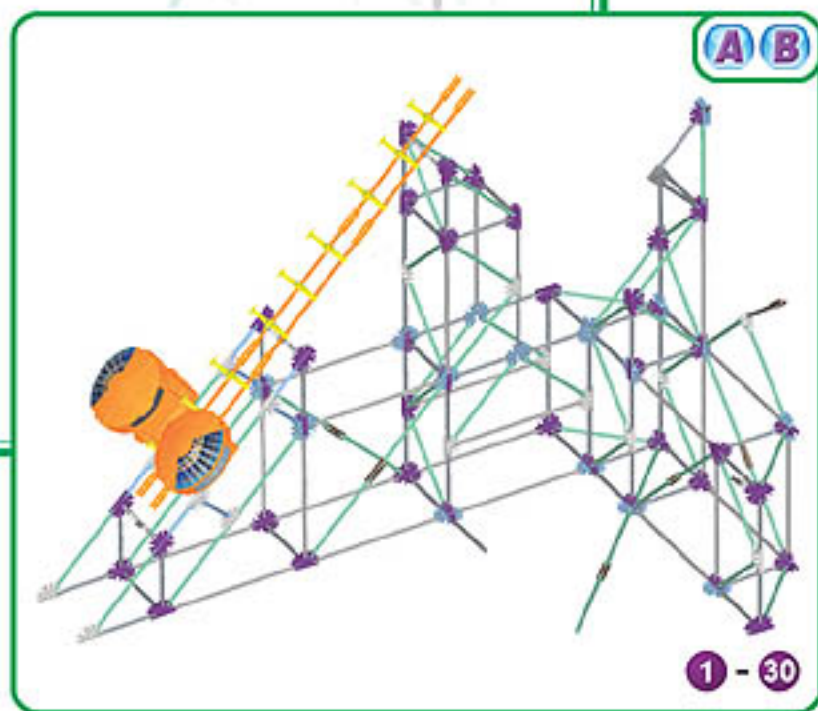

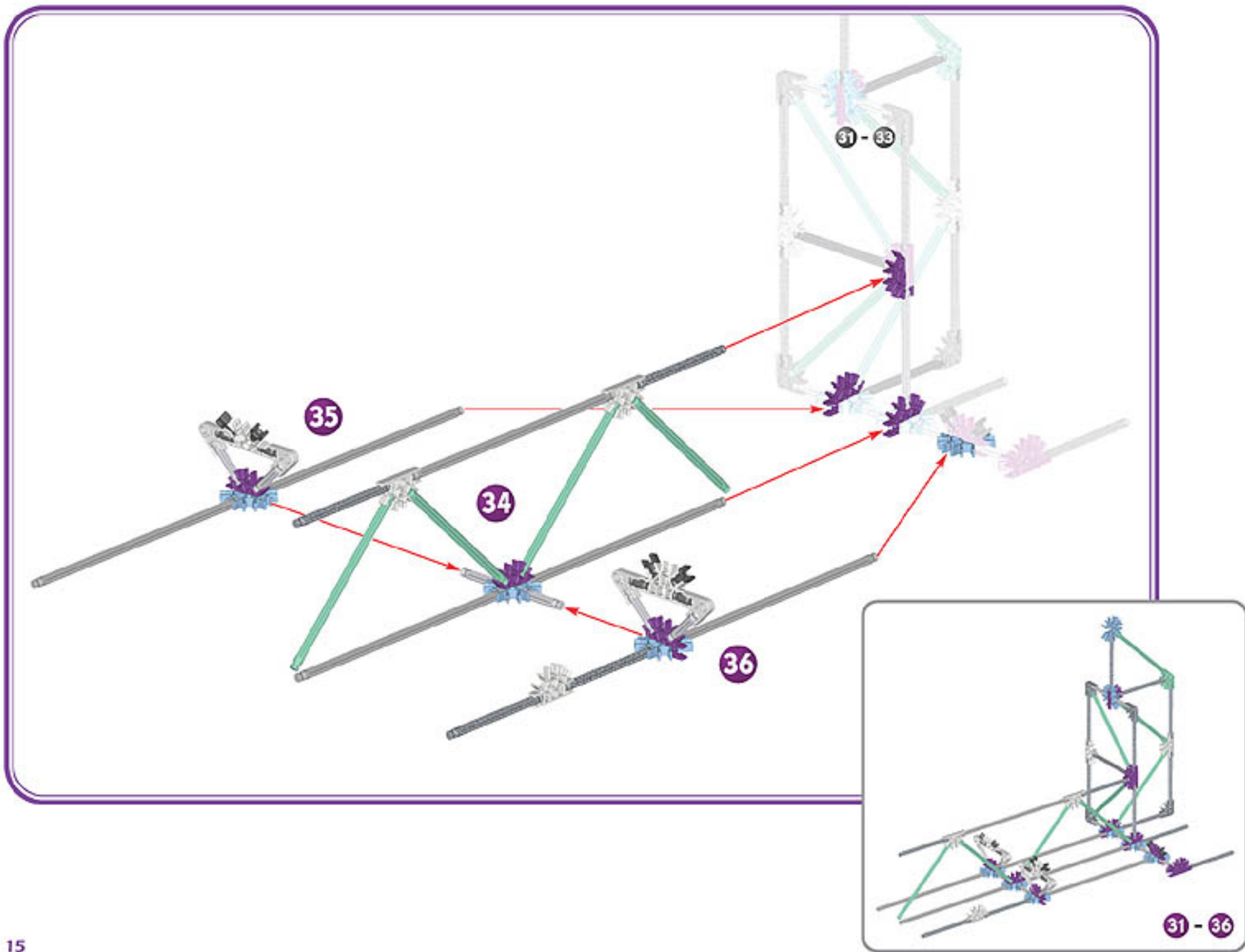

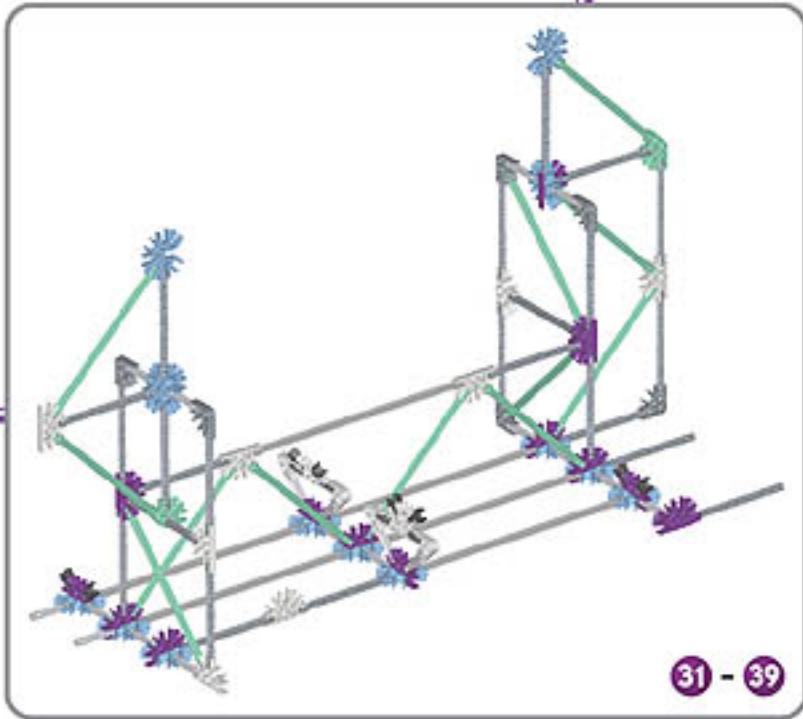
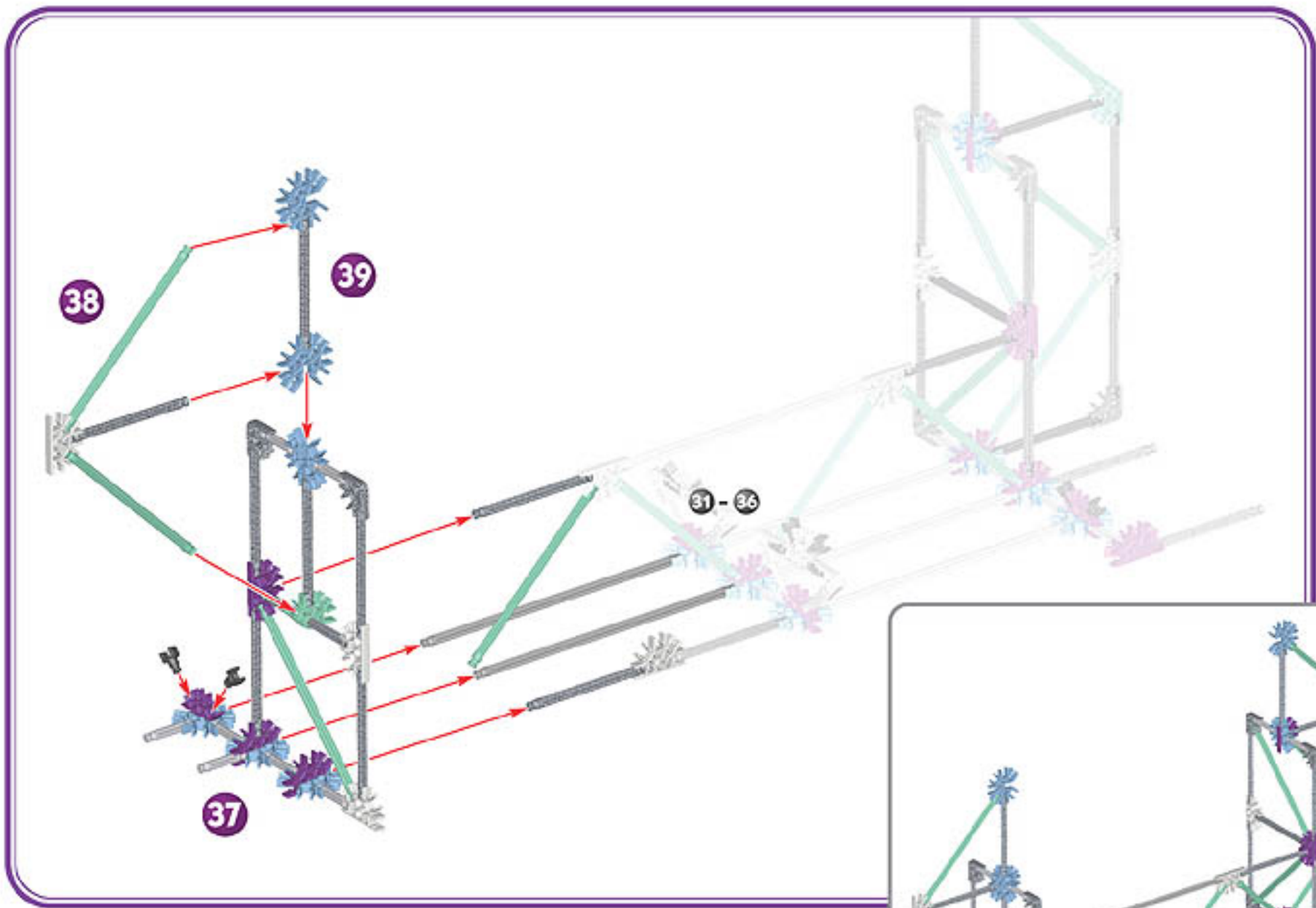

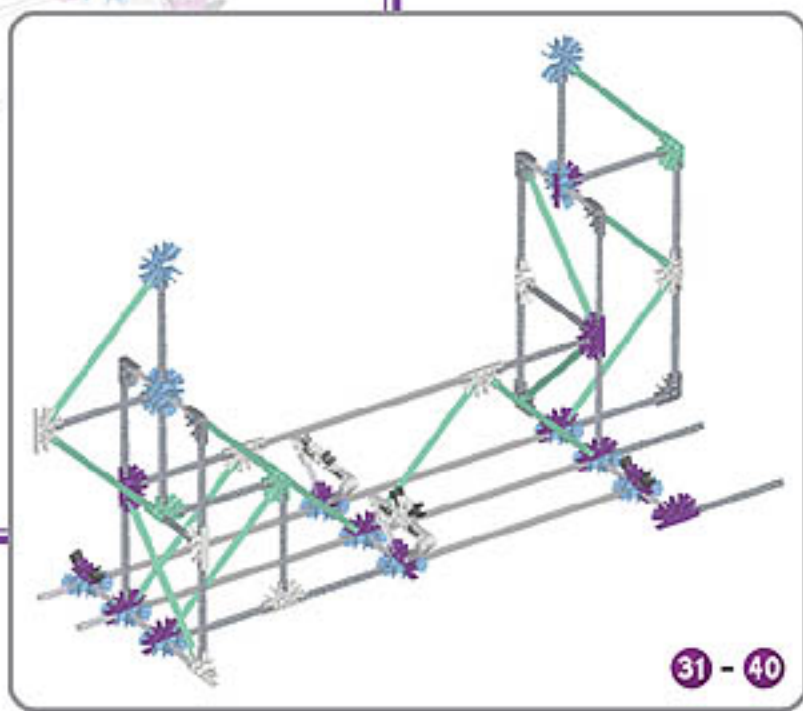
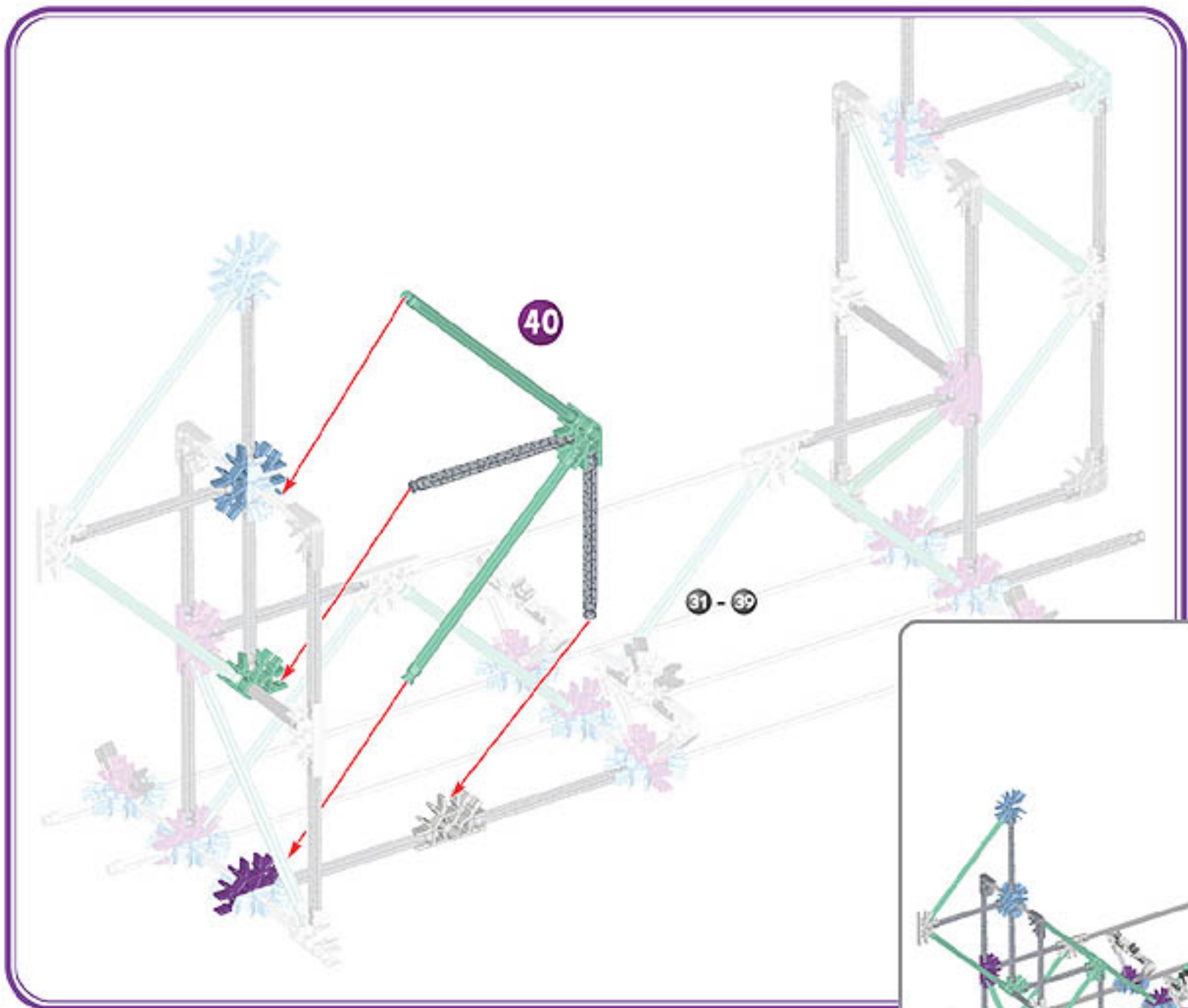

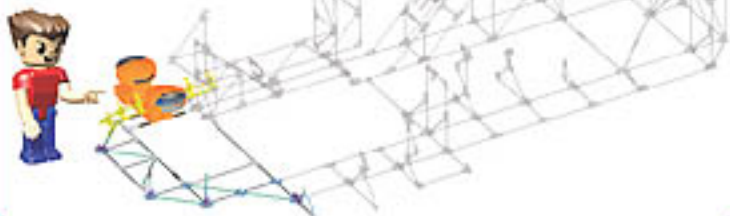
D

Install all batteries in the Turbo Booster before building.

Rods go into 2 upper holes on the Turbo Booster.

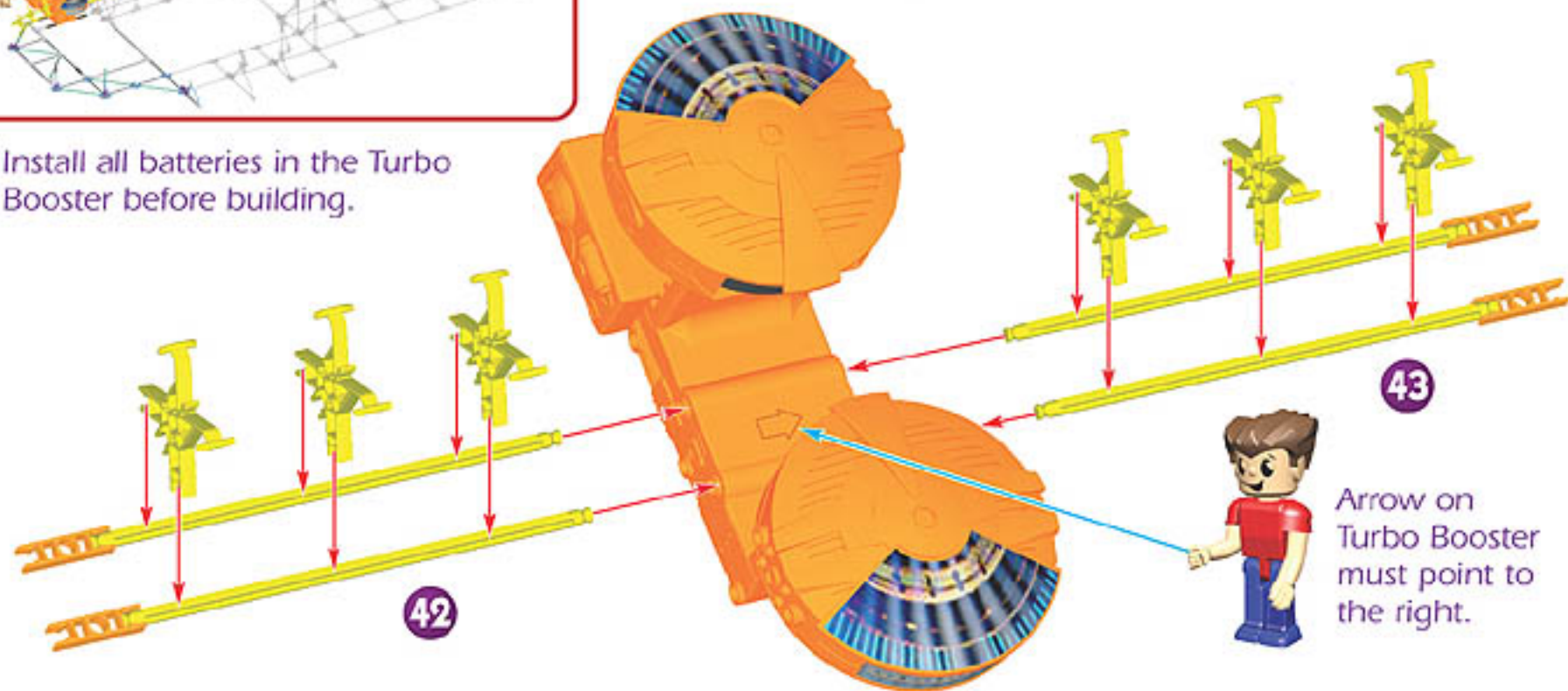

Push 2 Track Connectors against the Turbo Booster.





Connect the sections.
(Steps 1-30, Steps 31-40)

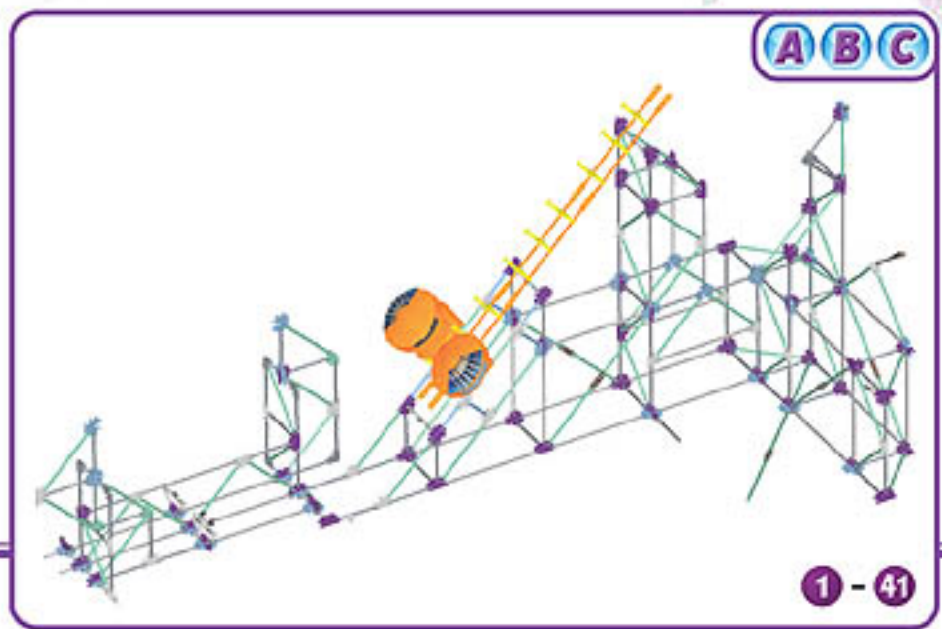
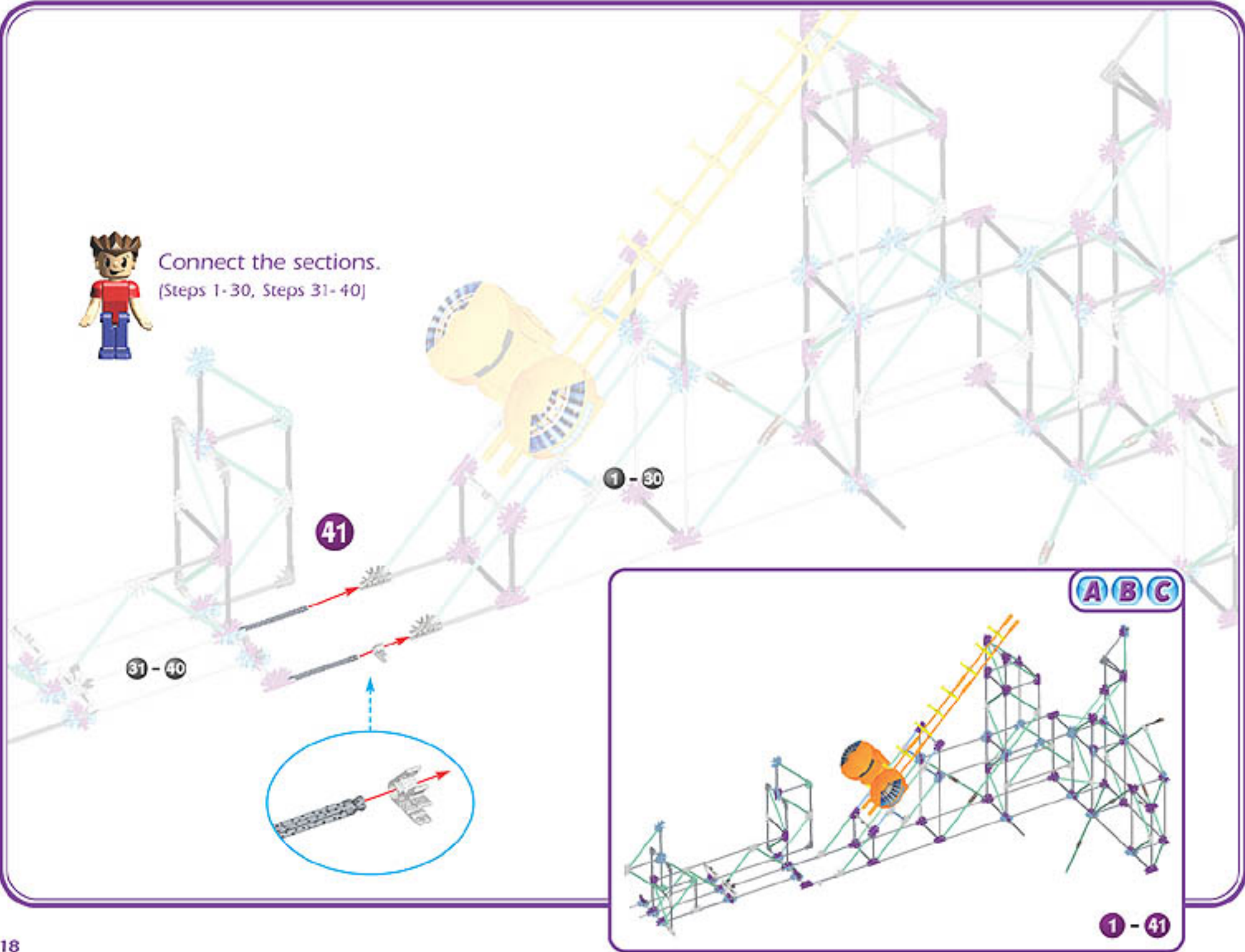

Underneath View.

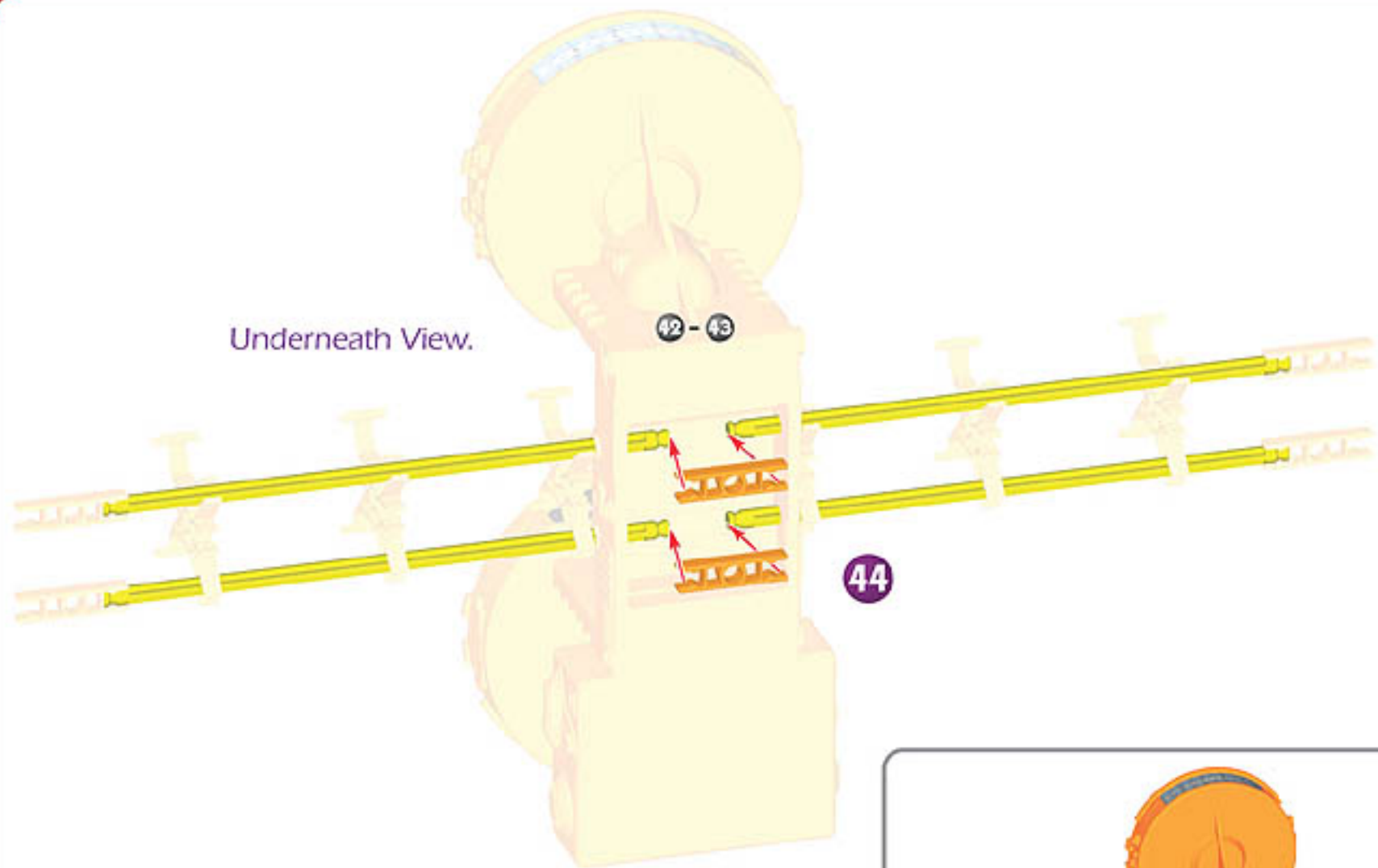

44

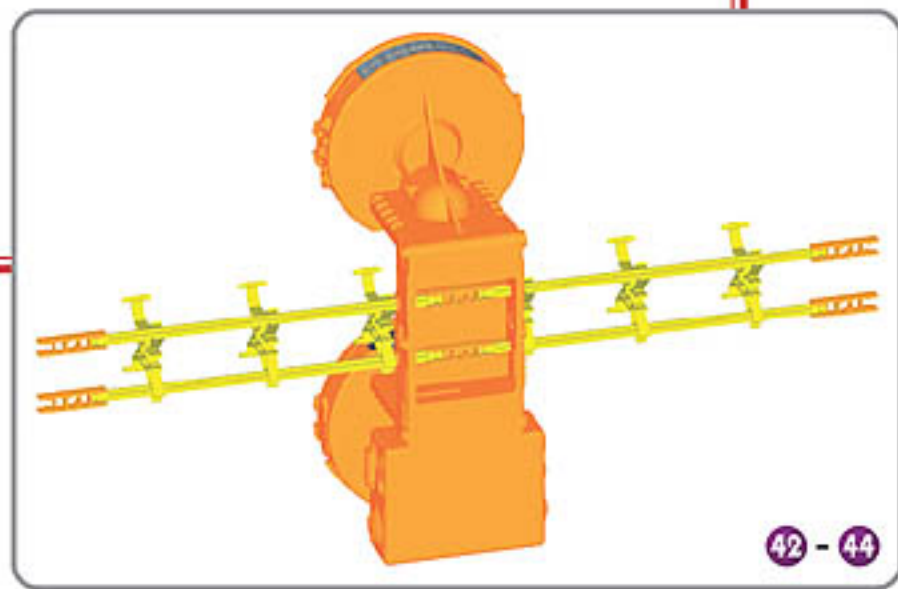

42 - 44

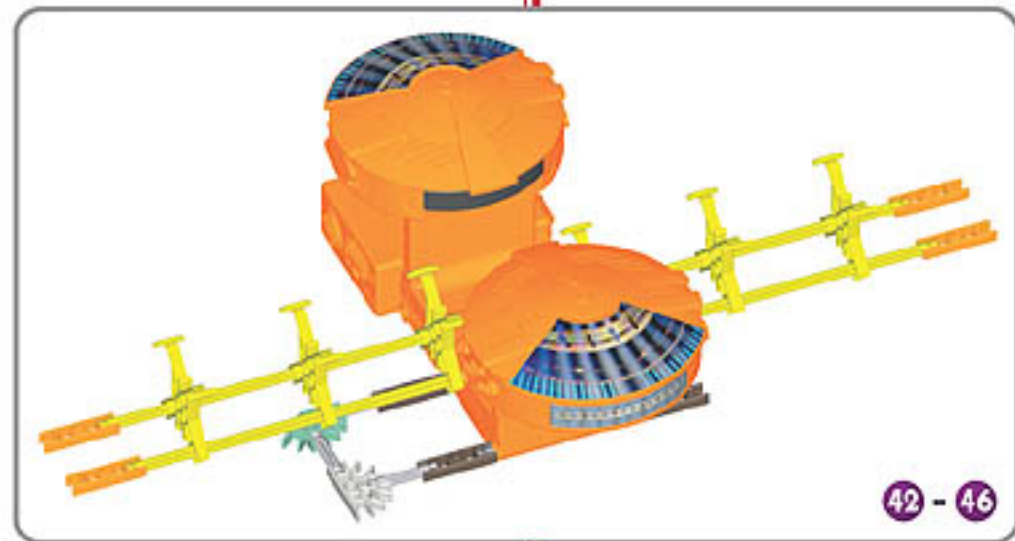
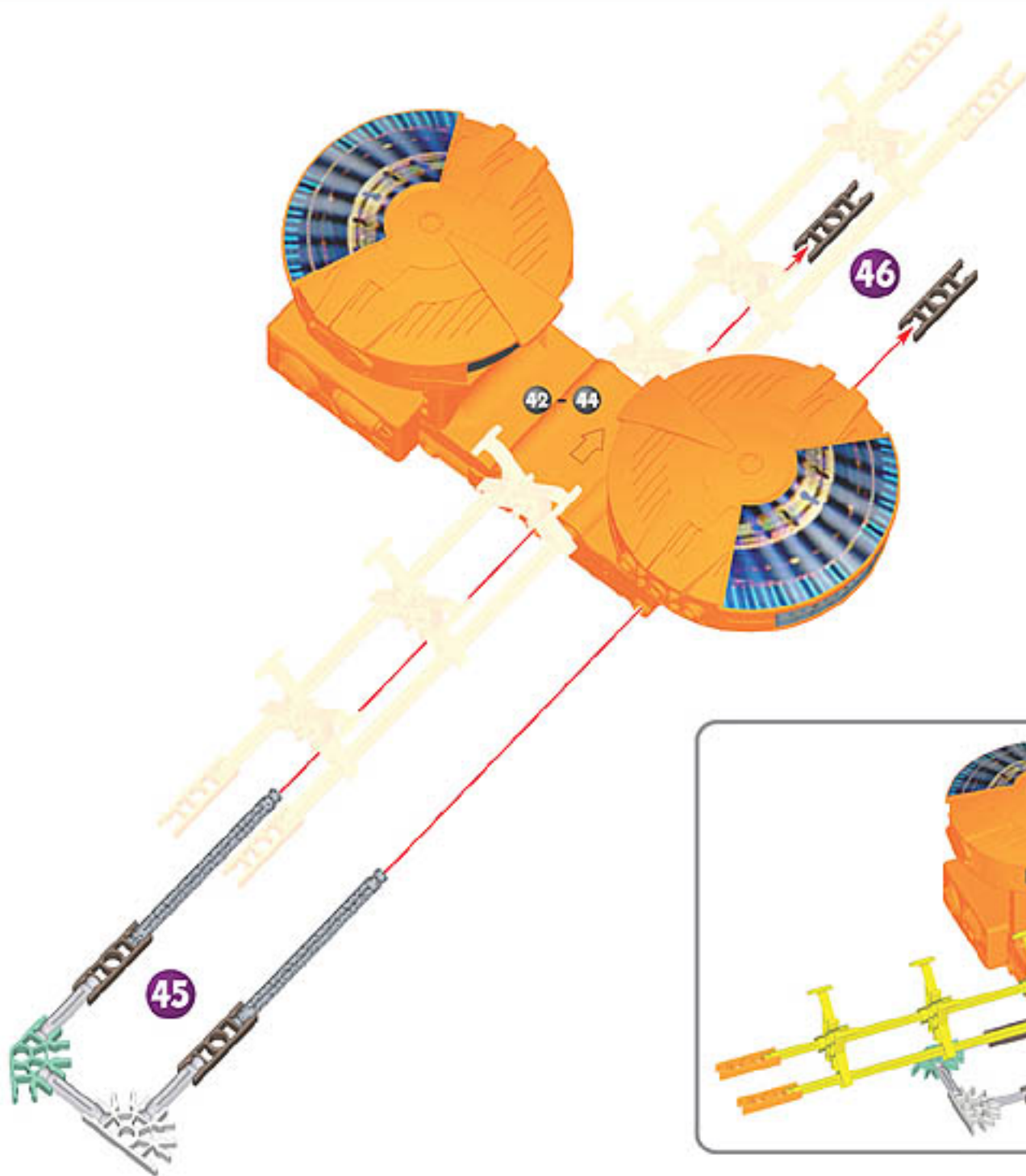

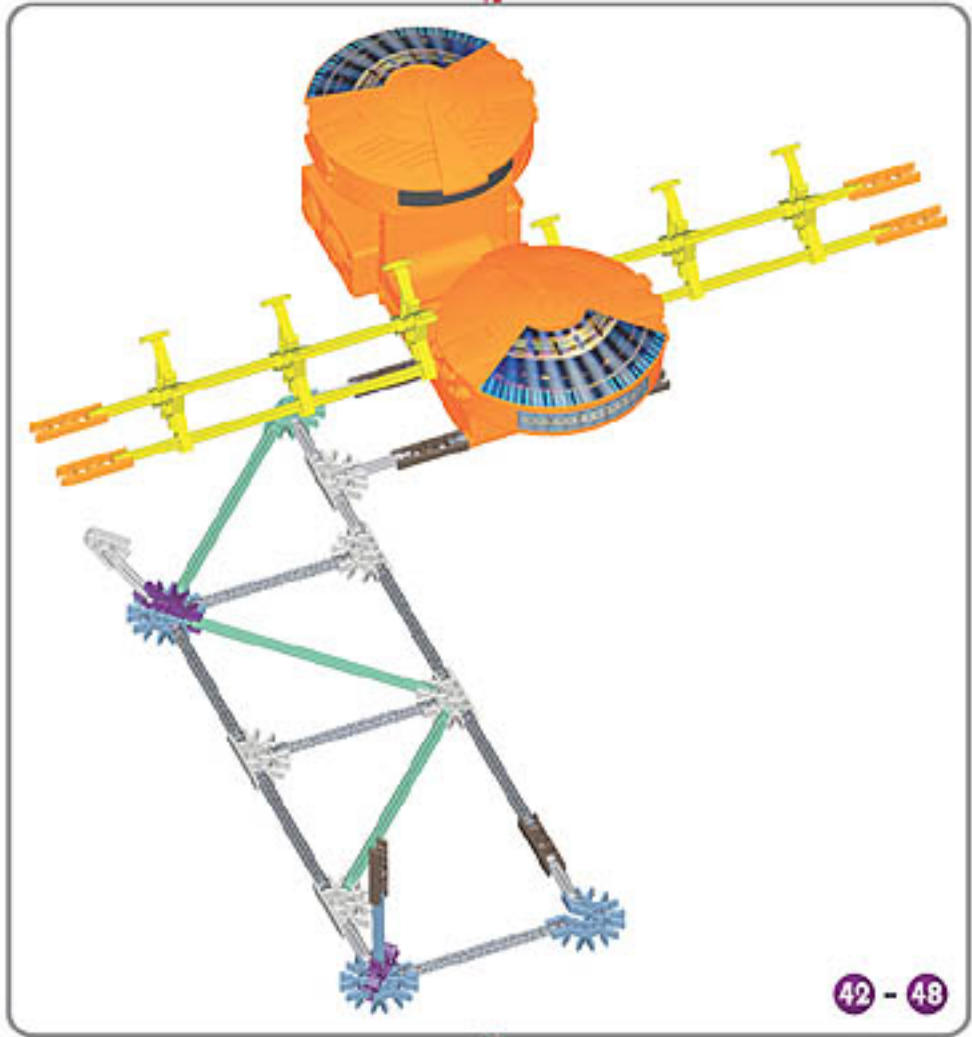
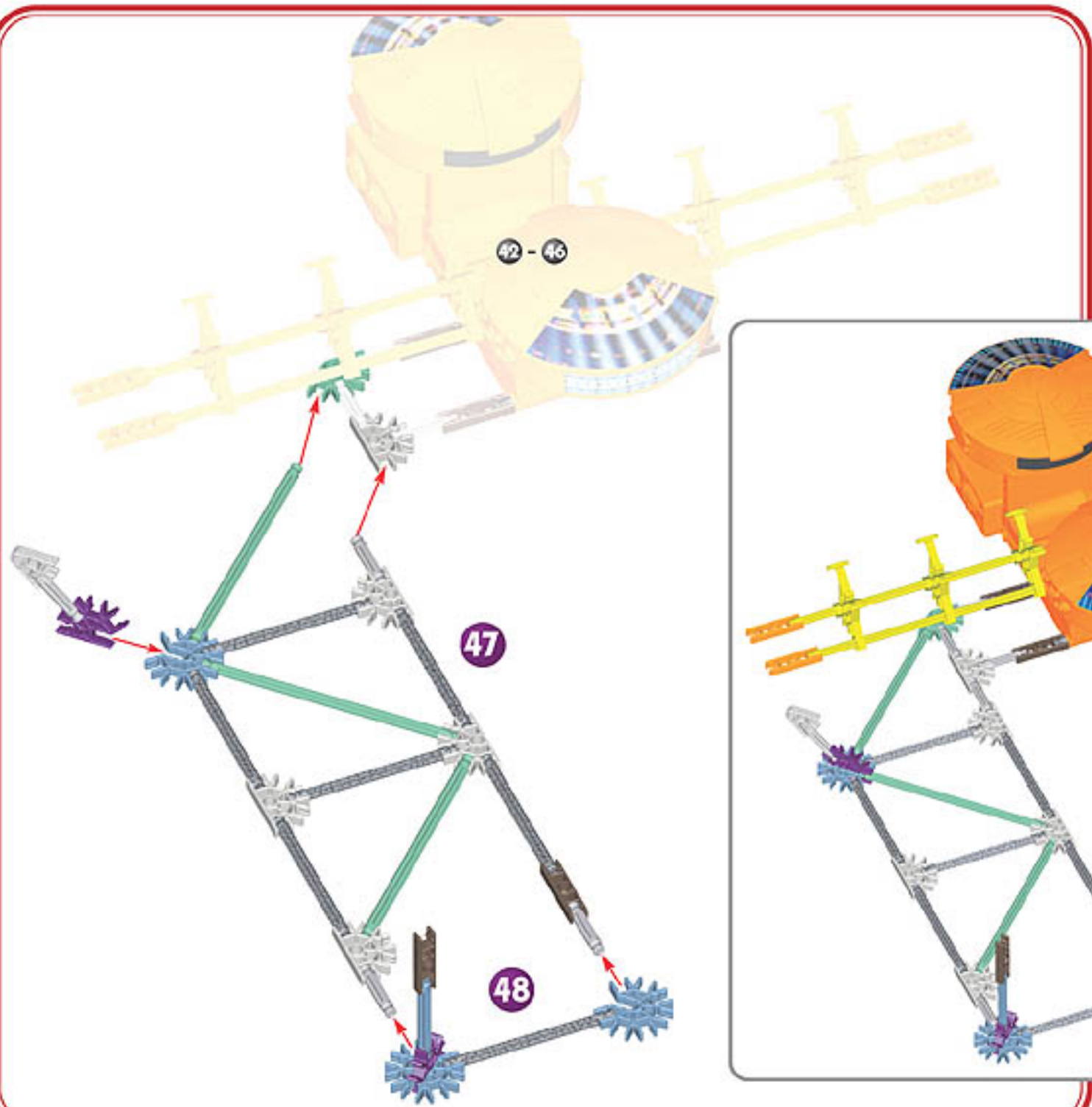

42 - 48

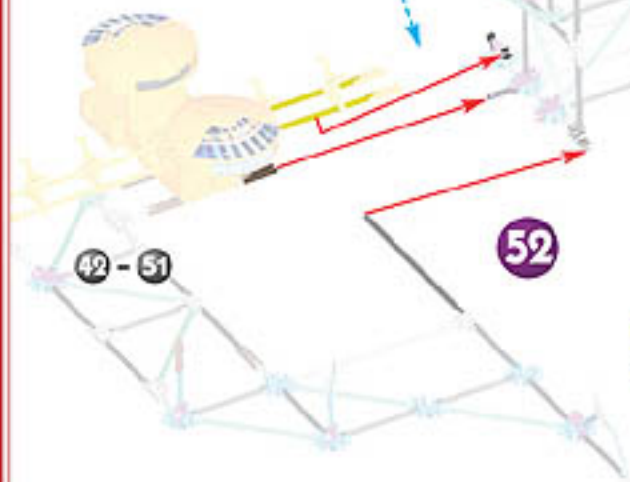
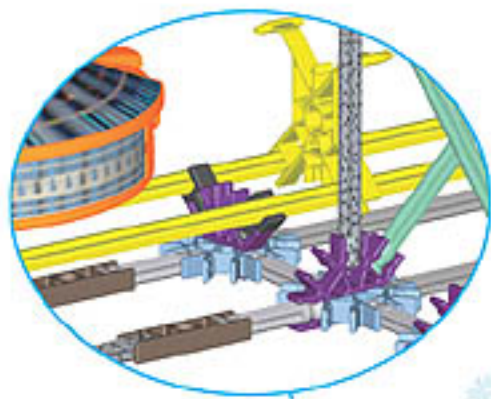

Connect the sections.
(Steps 1-41, Steps 42-51)

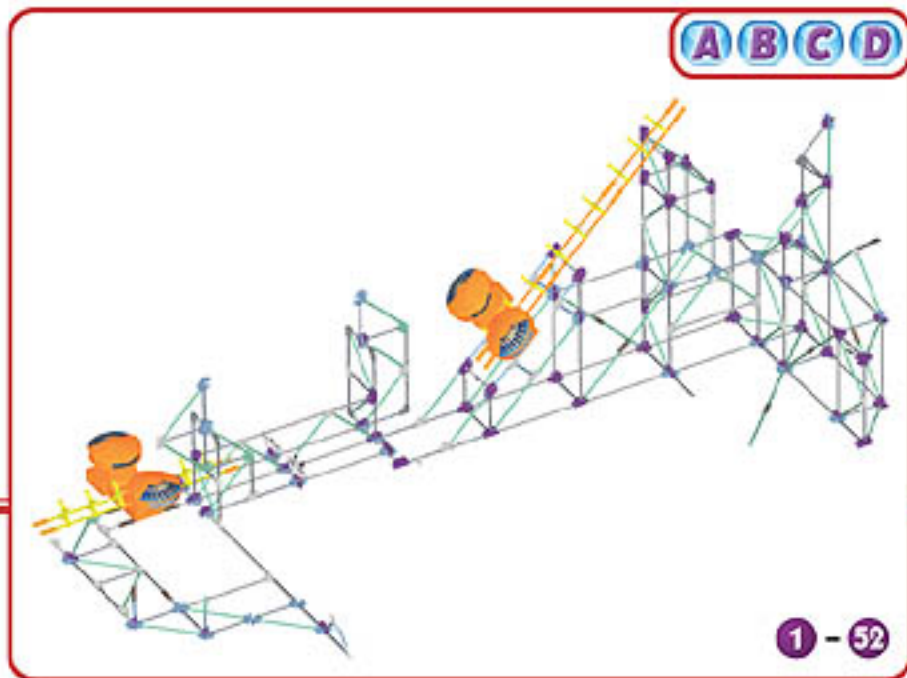

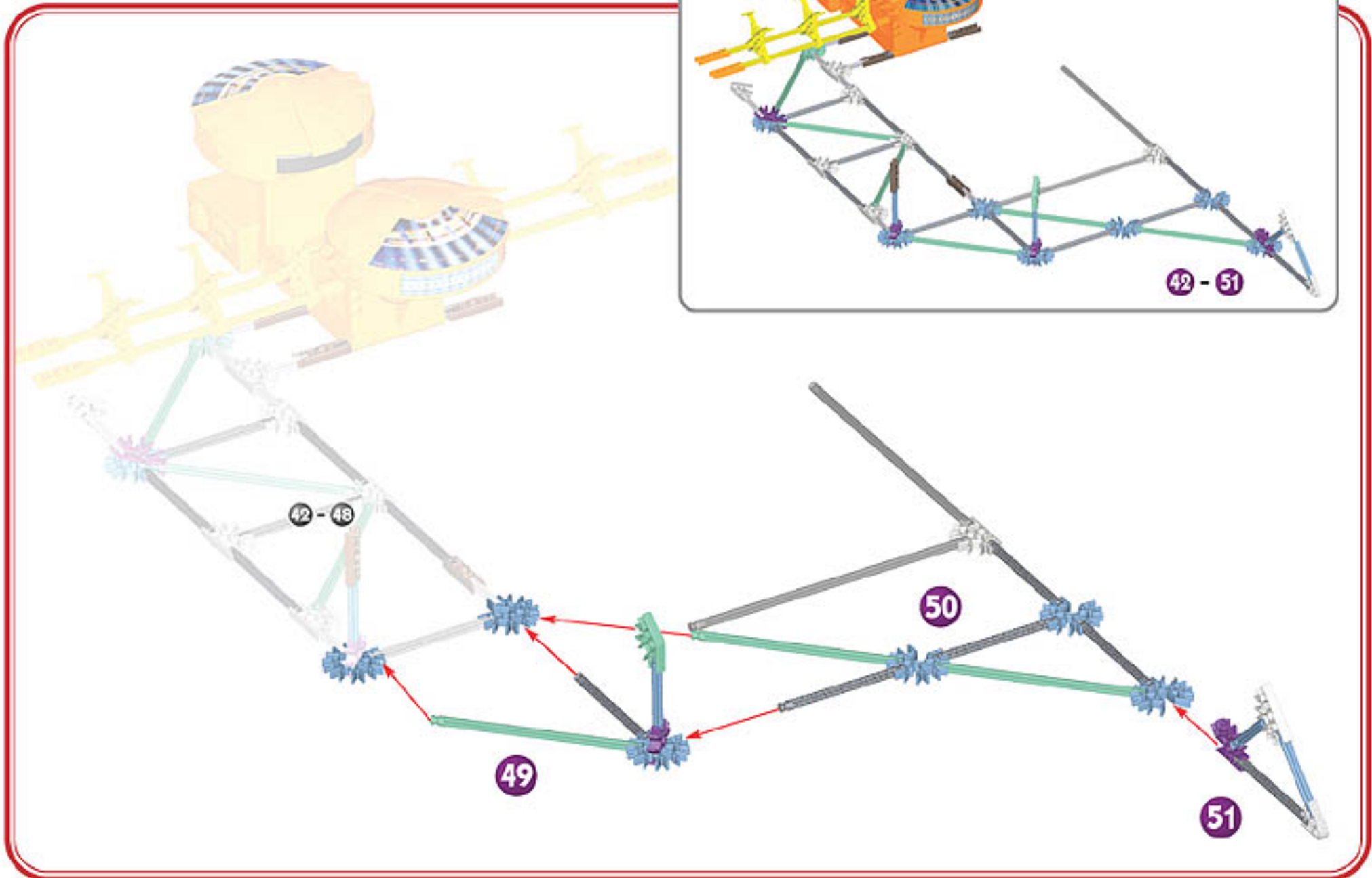

E

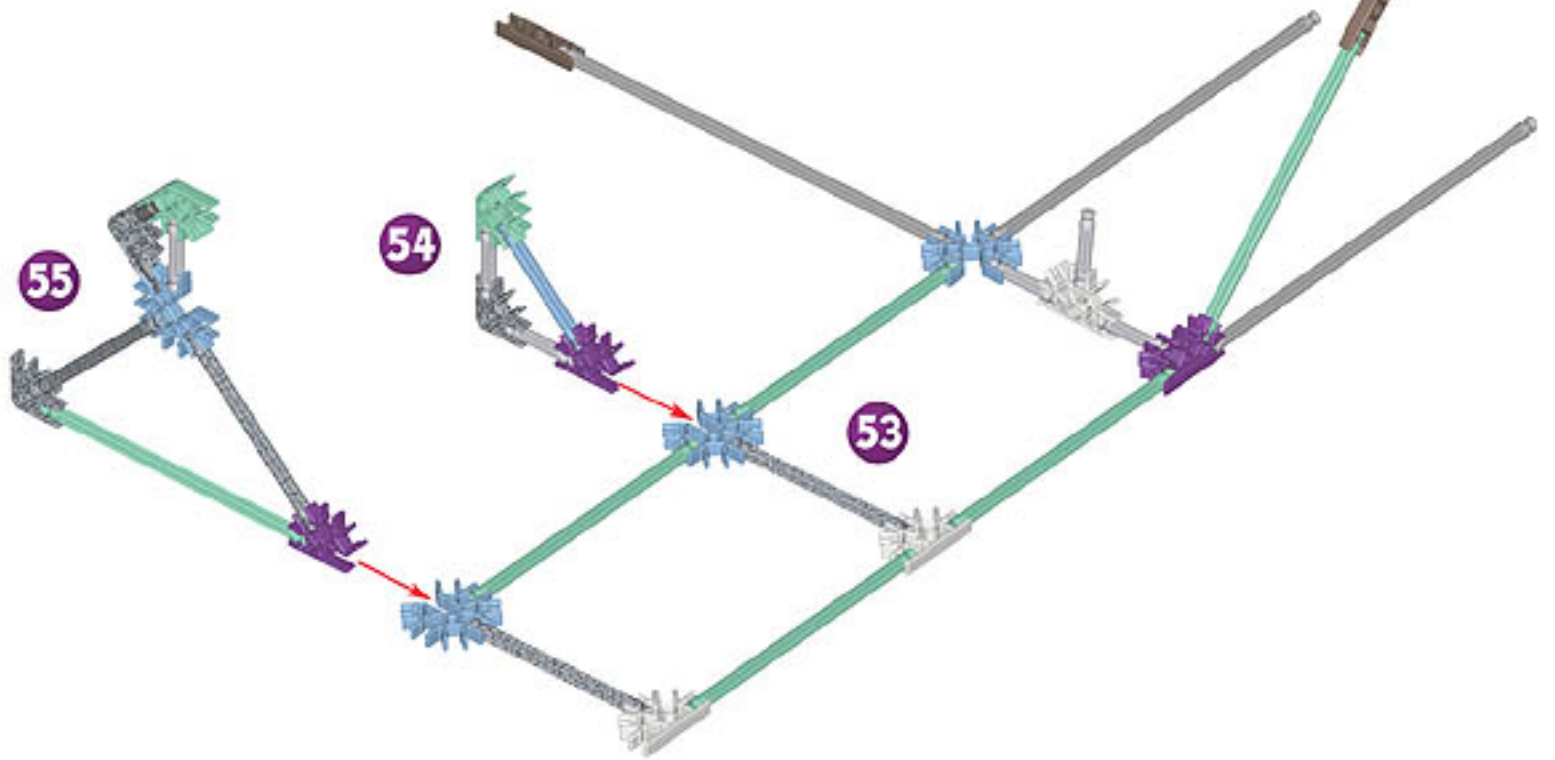
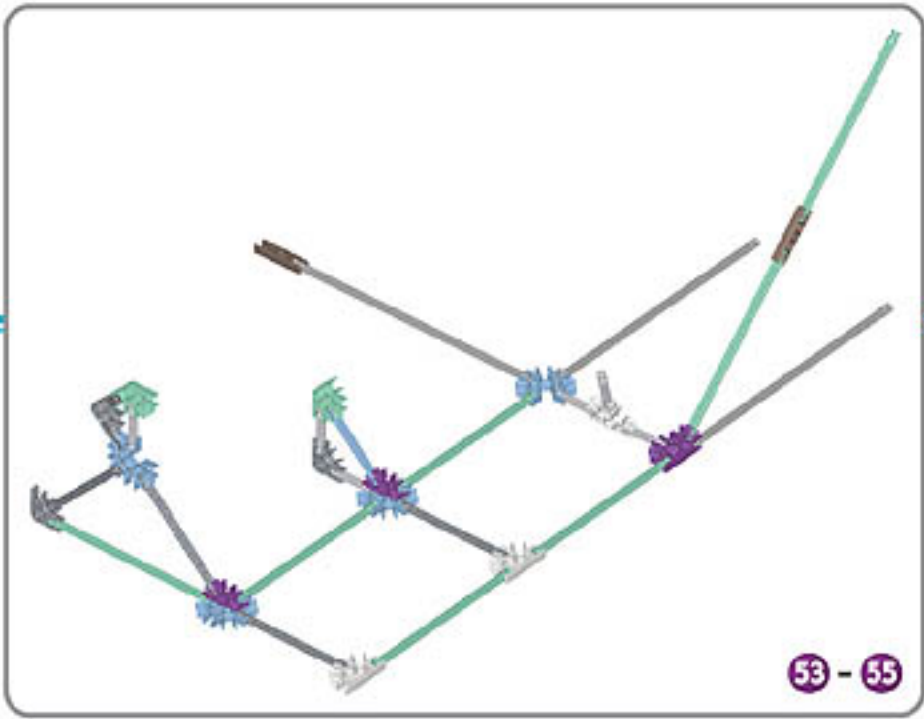
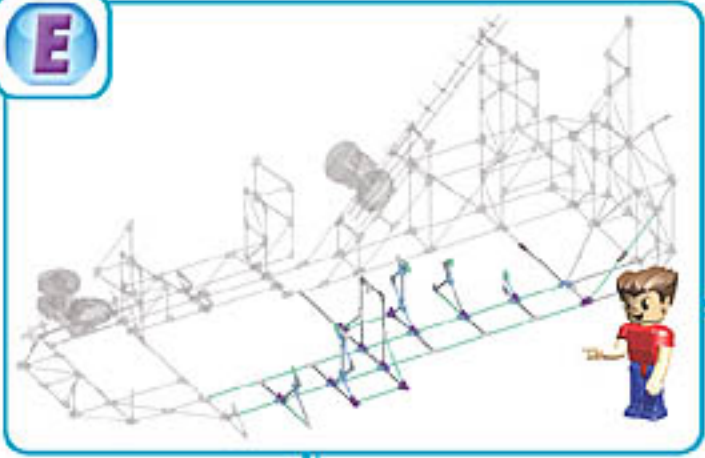

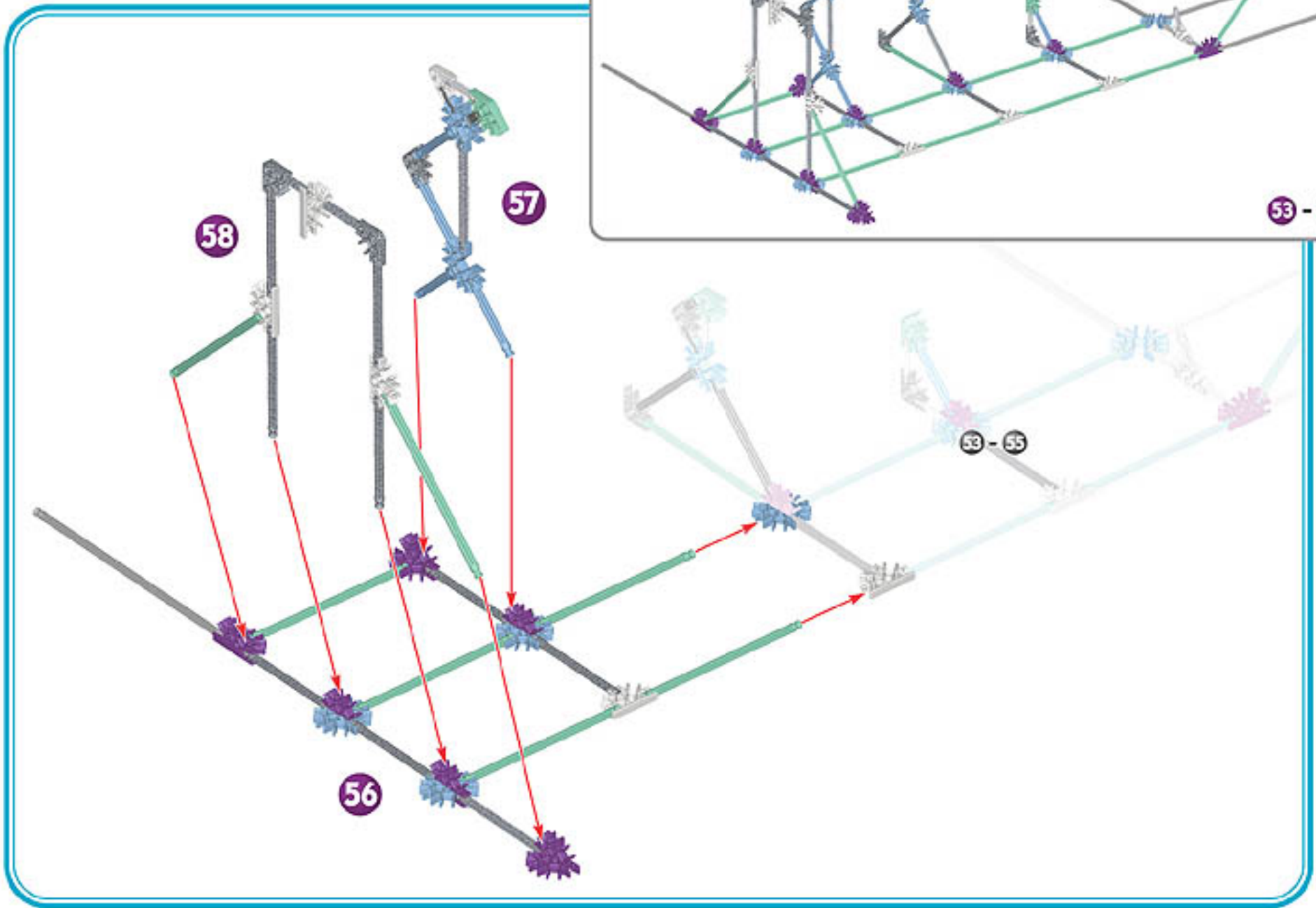
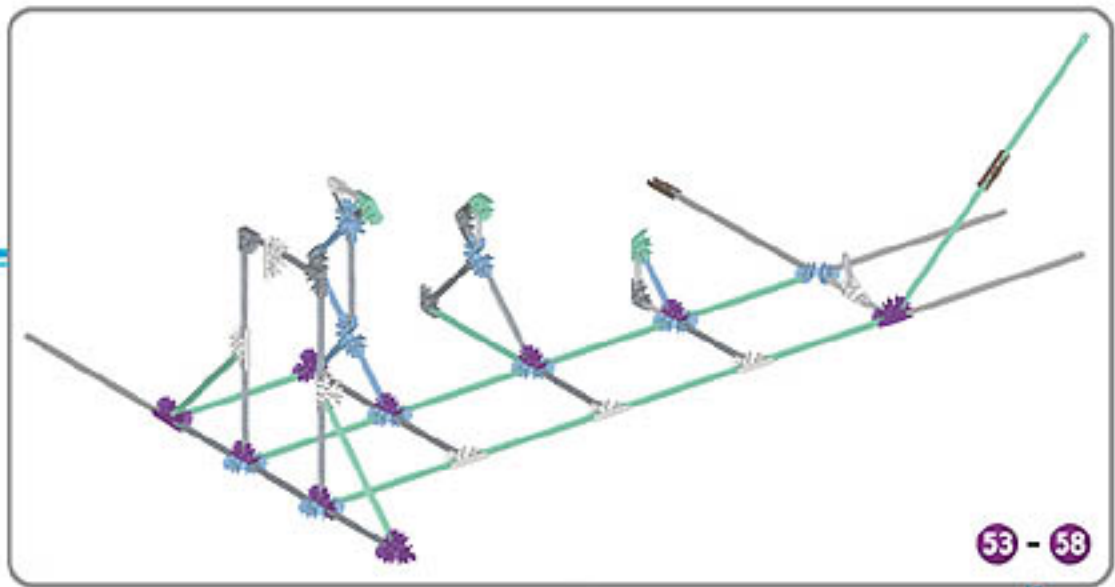

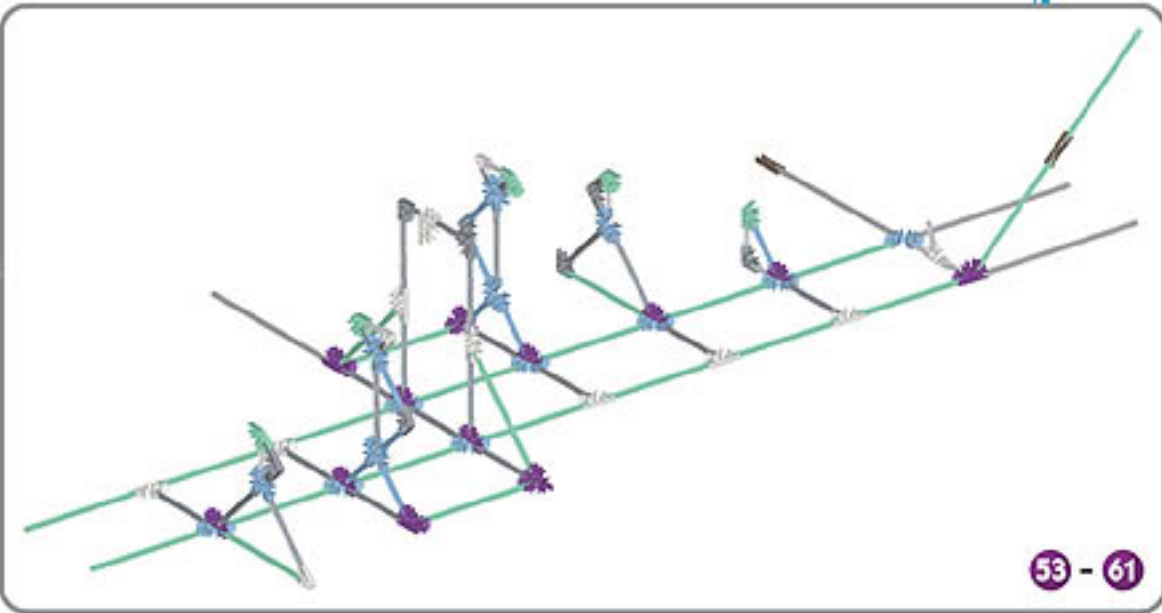
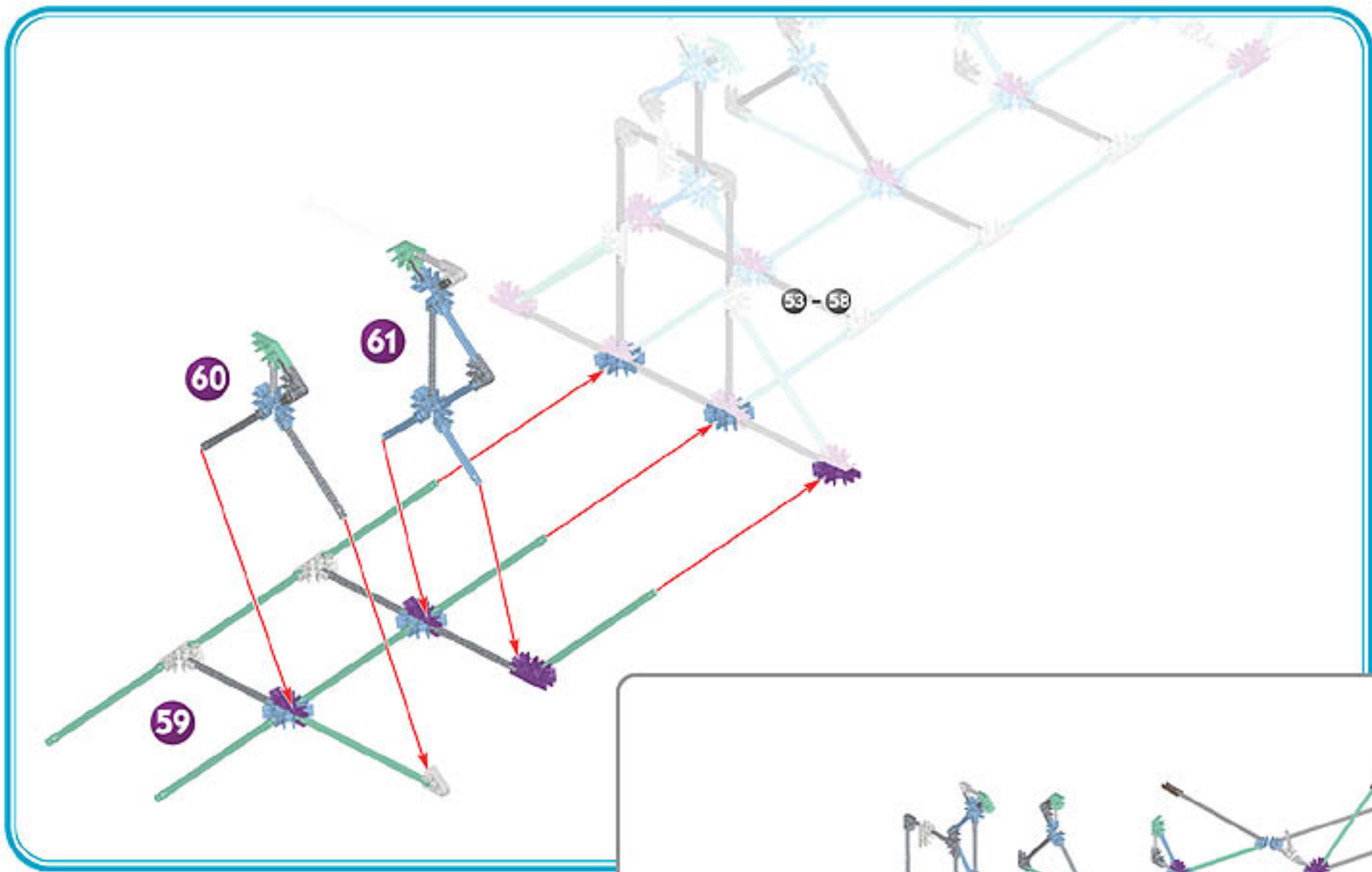



Now it's time to put on the Track Connectors!
Pay close attention to number and placement.
Start at the bottom of the loop on the next page.

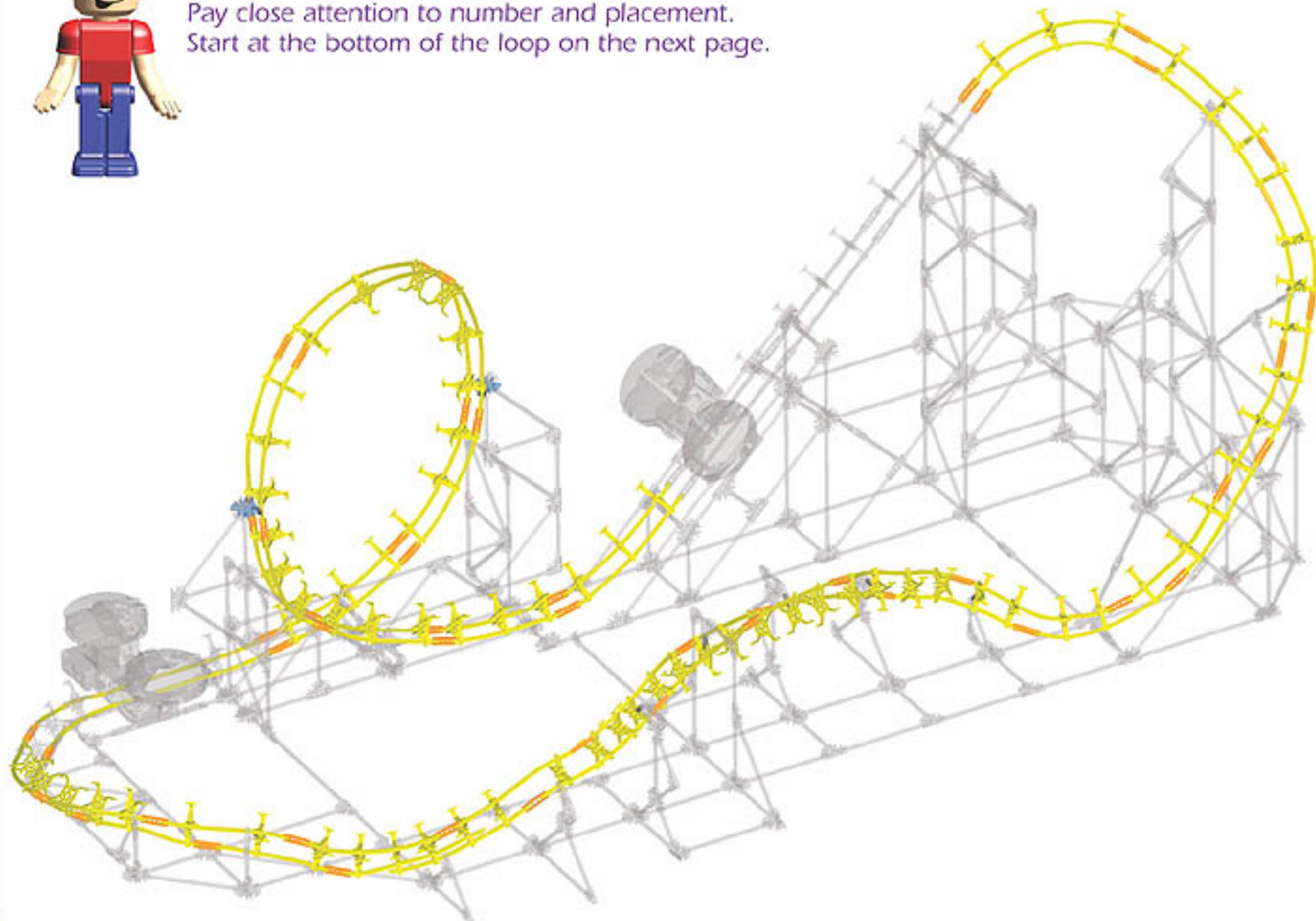

A B C D E

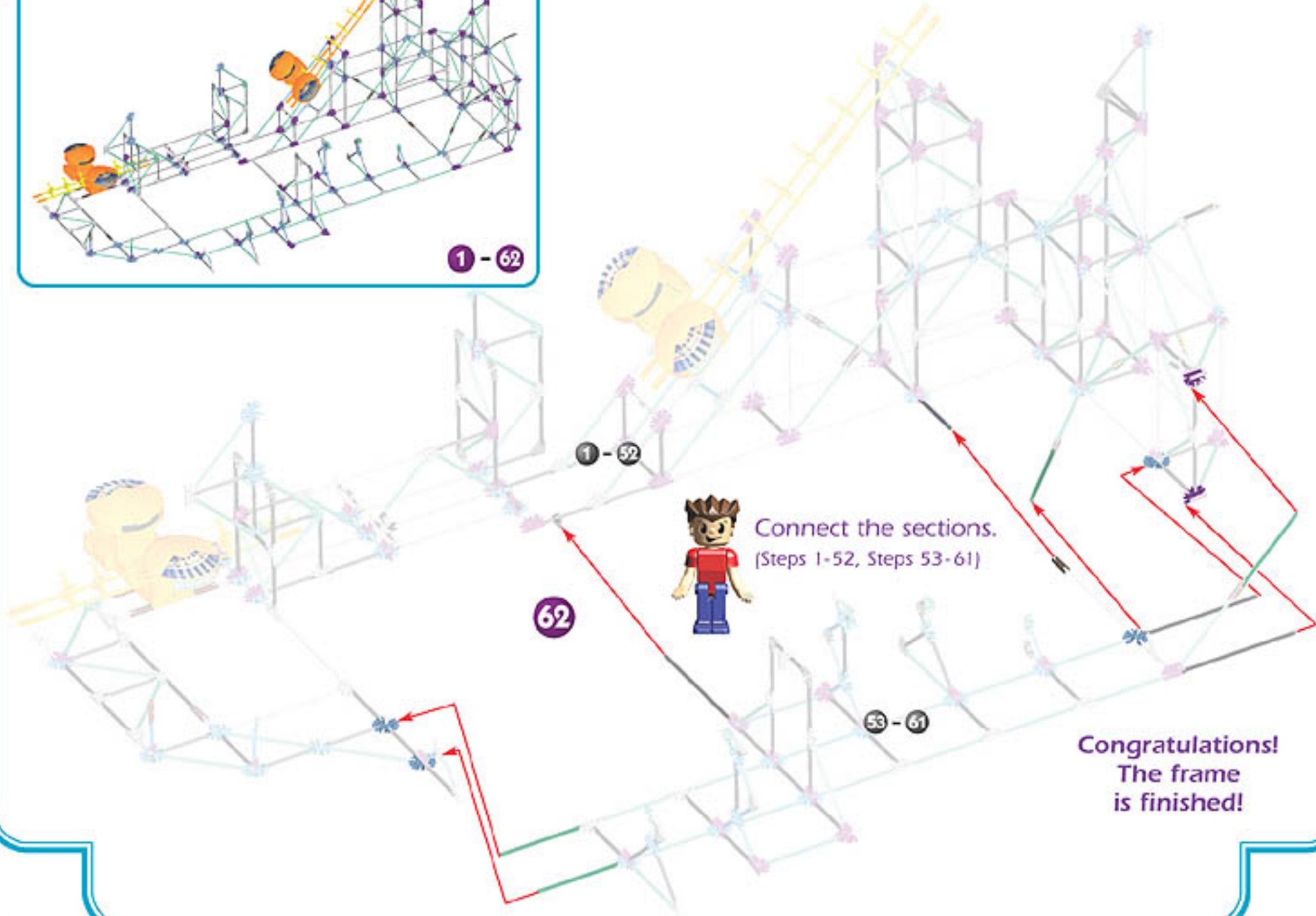
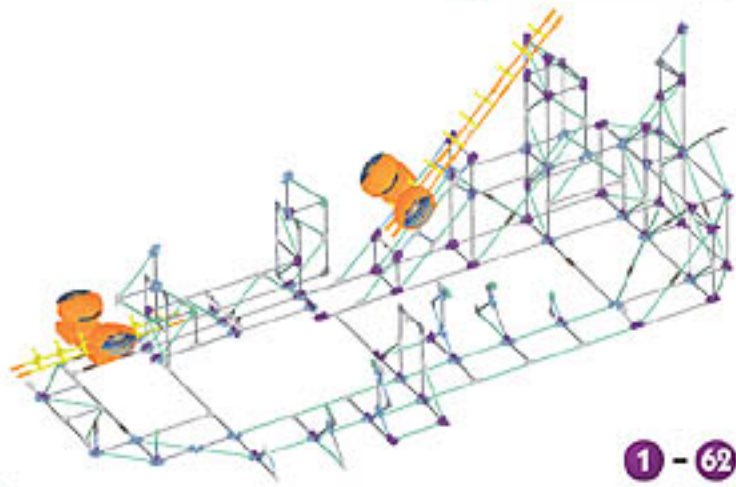

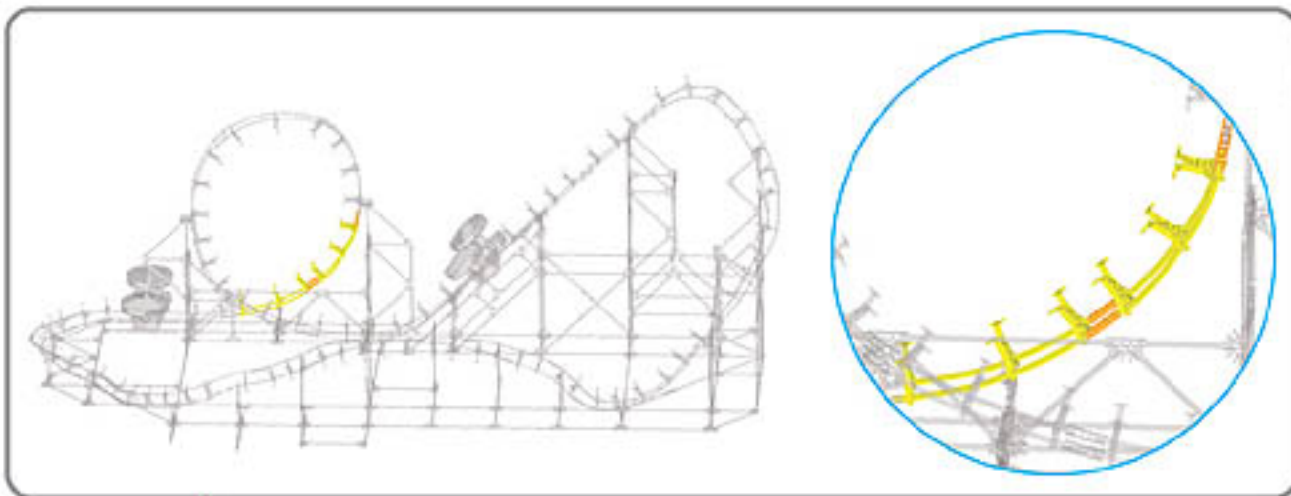

x6
 Number of Track Connectors

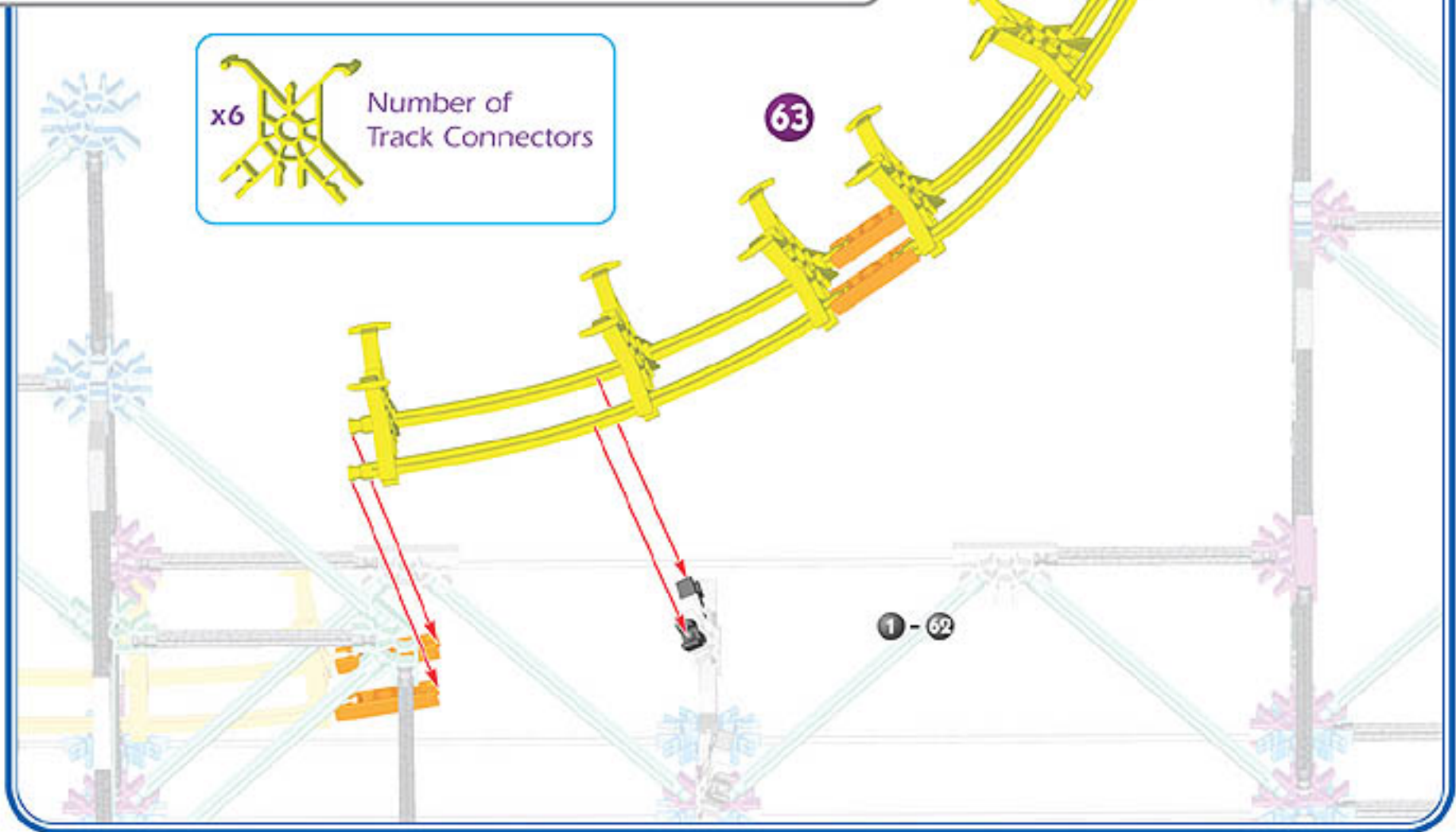

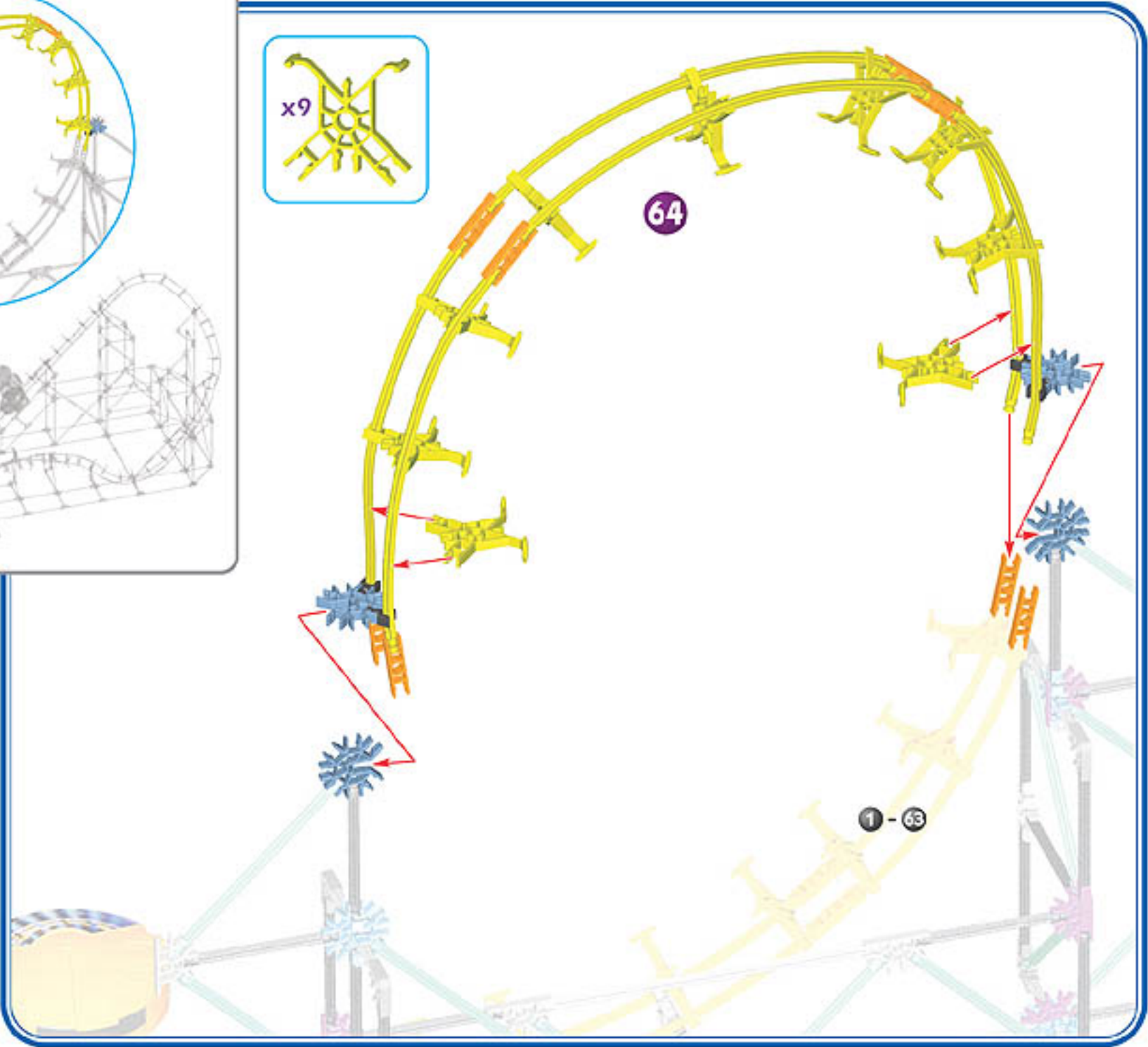
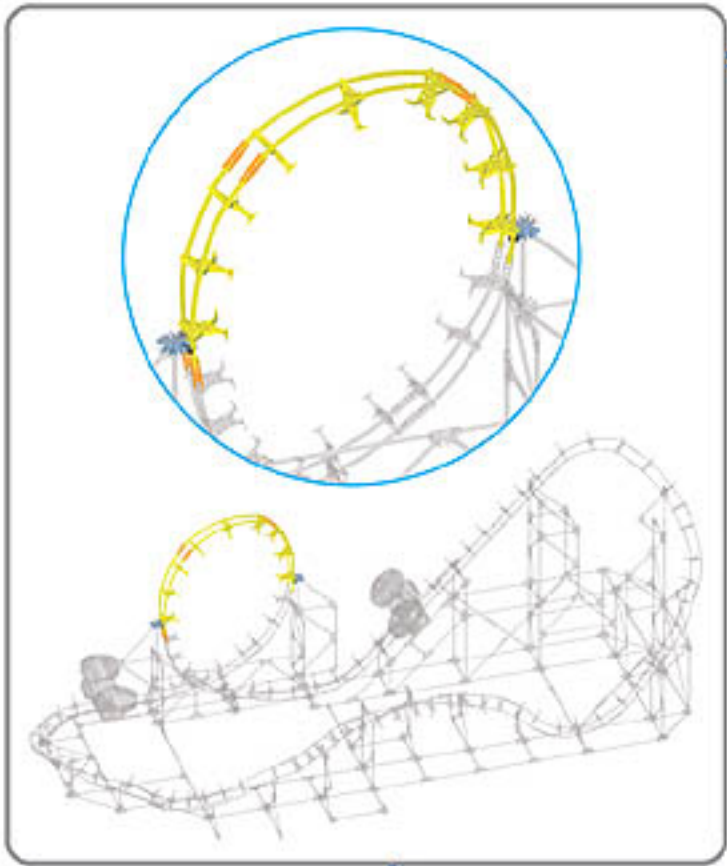

x6



65

1 - 64

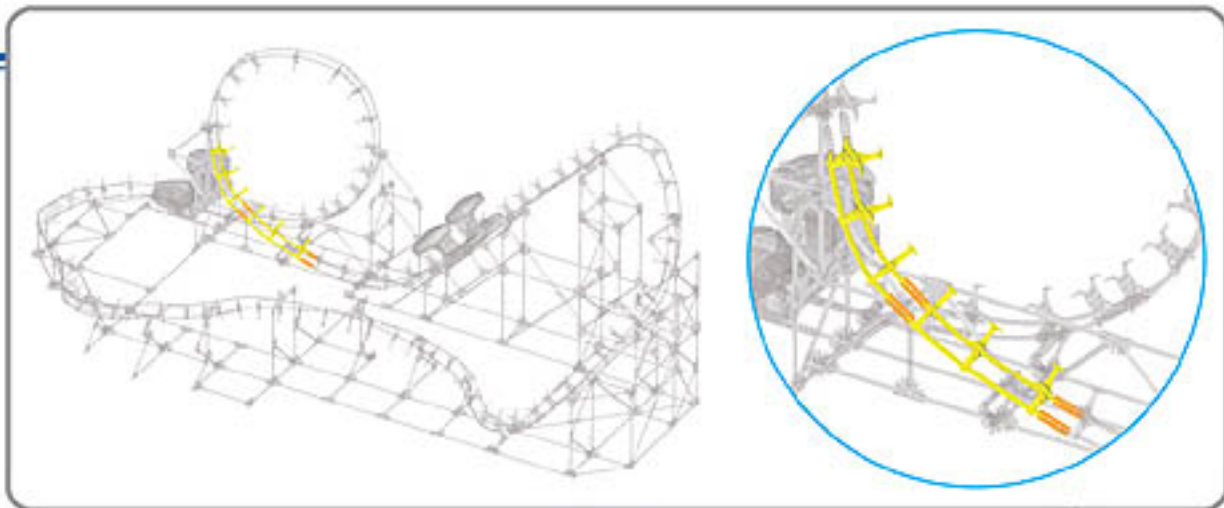

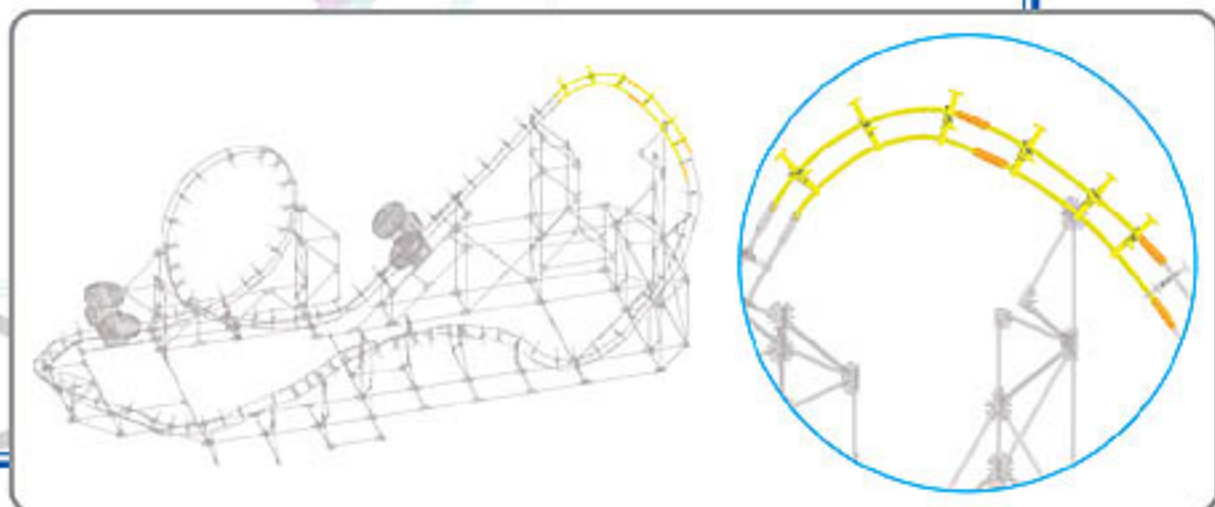
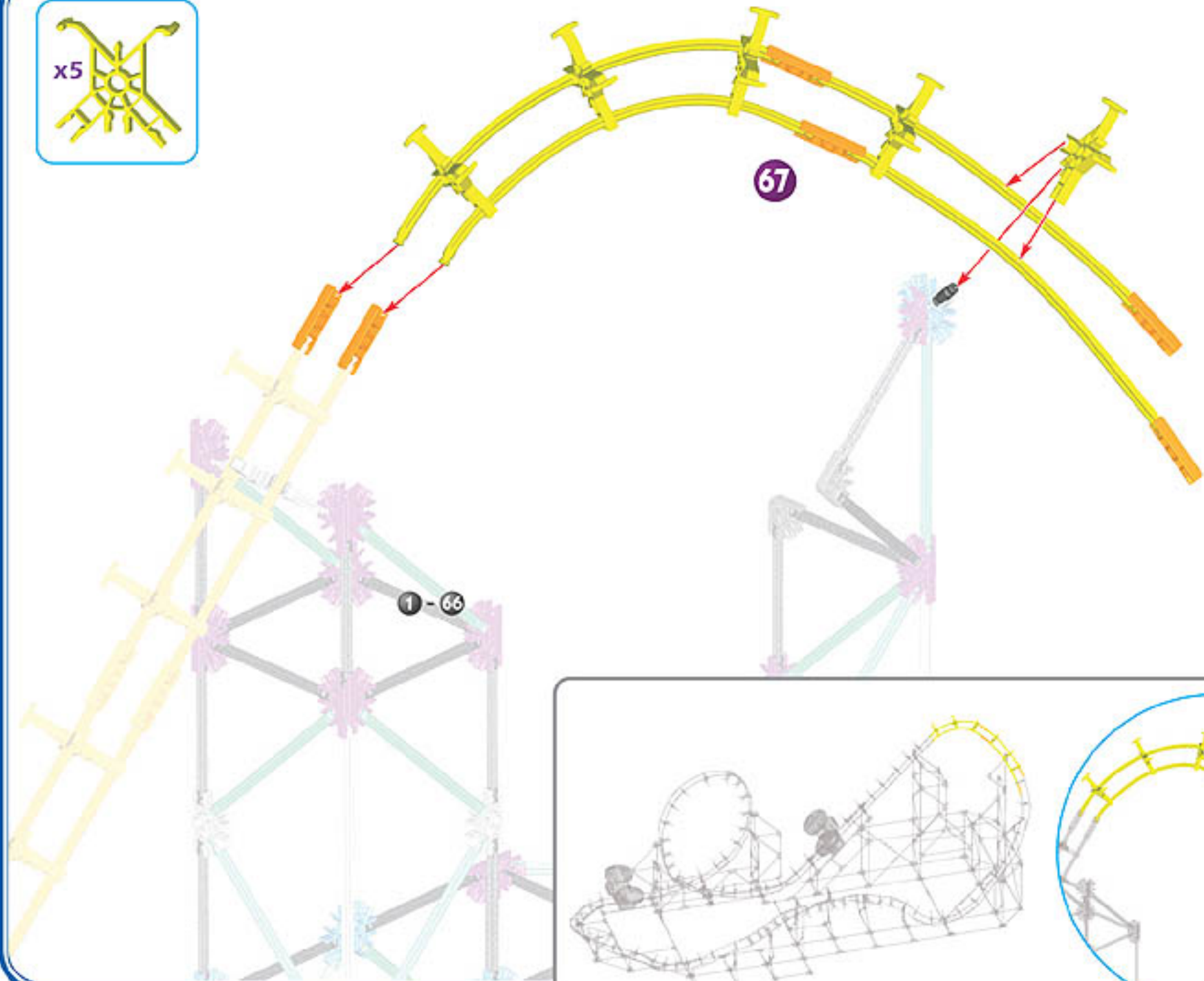

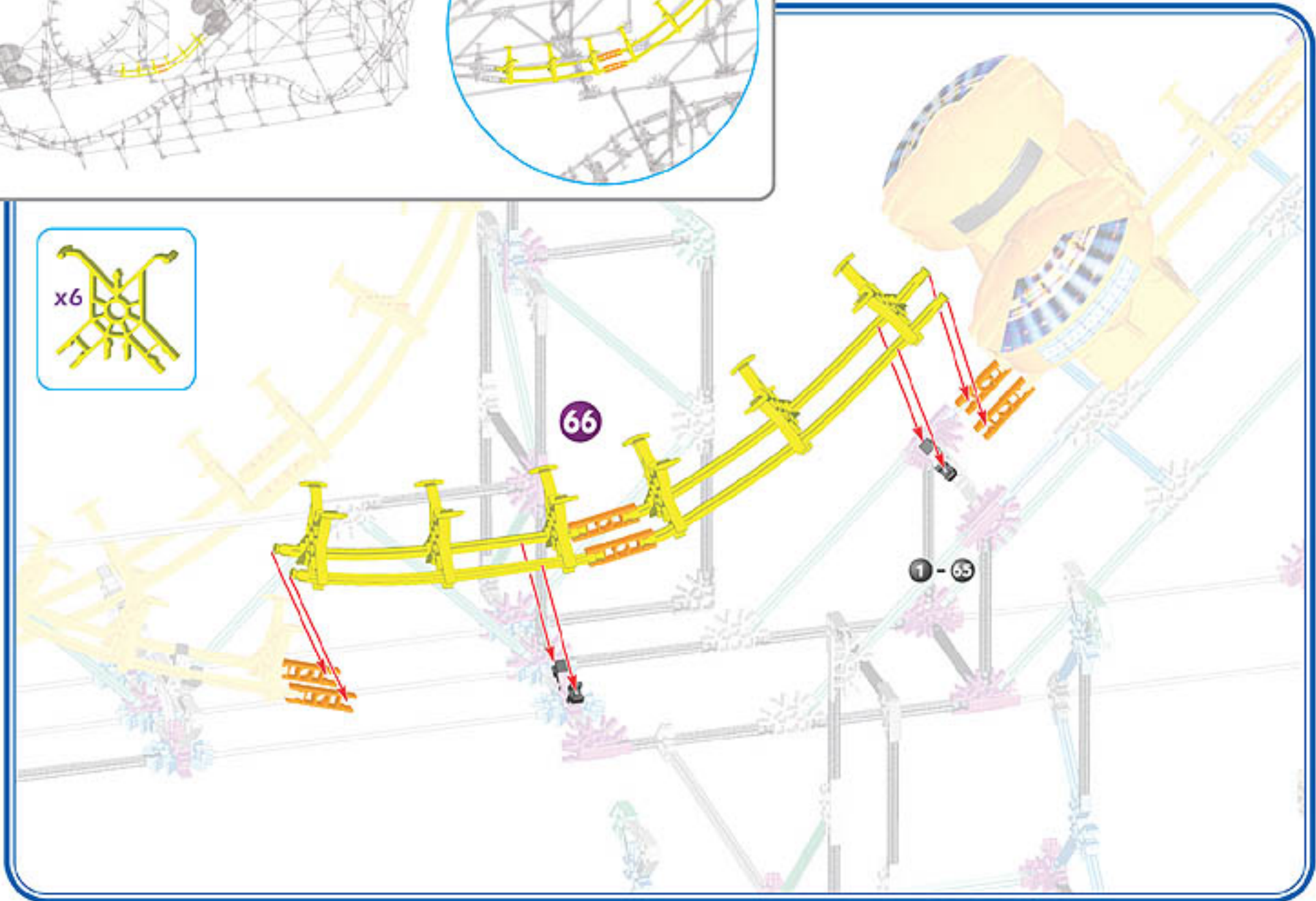
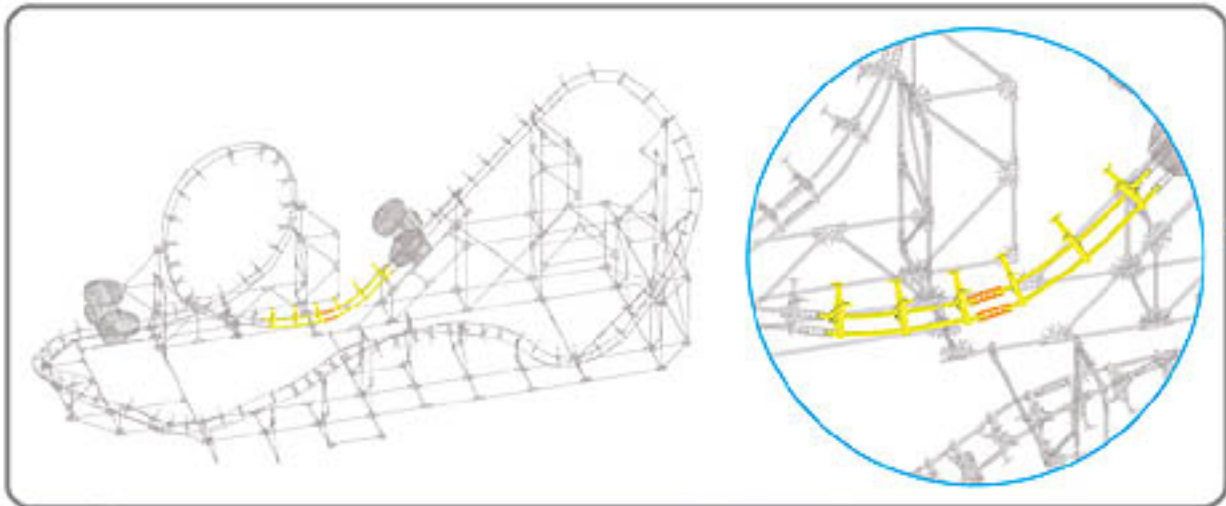

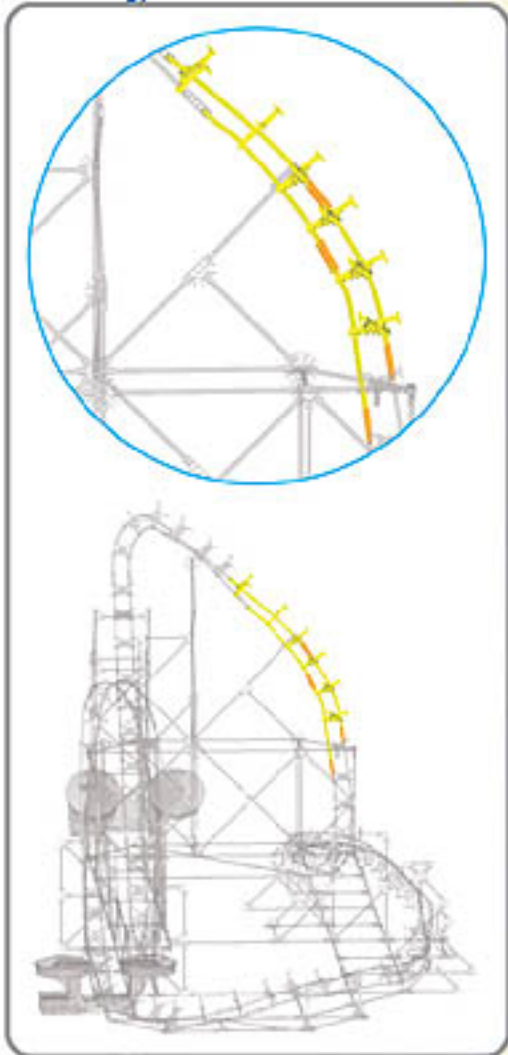

68

1 - 57

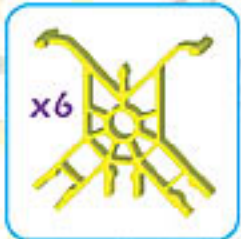
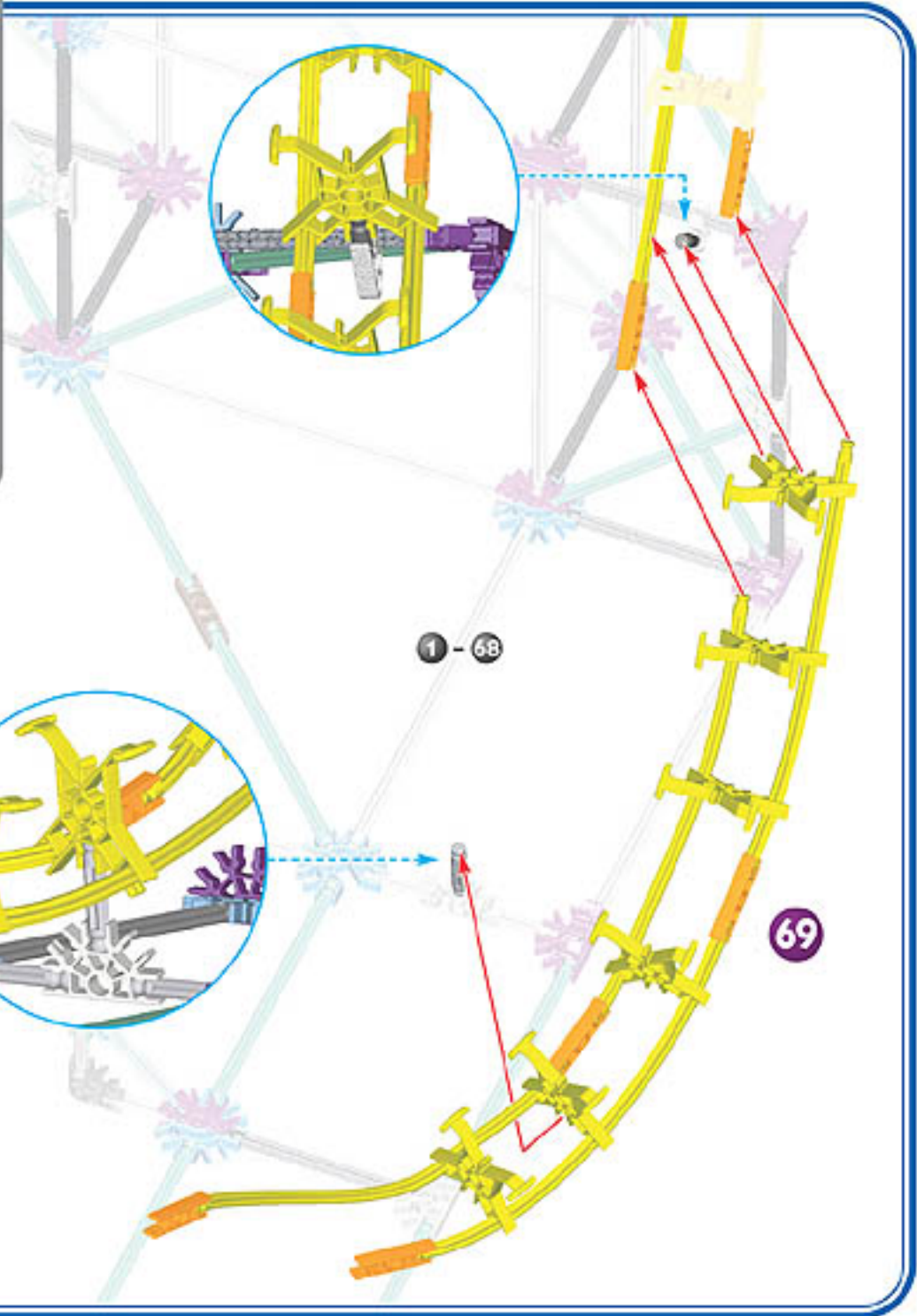
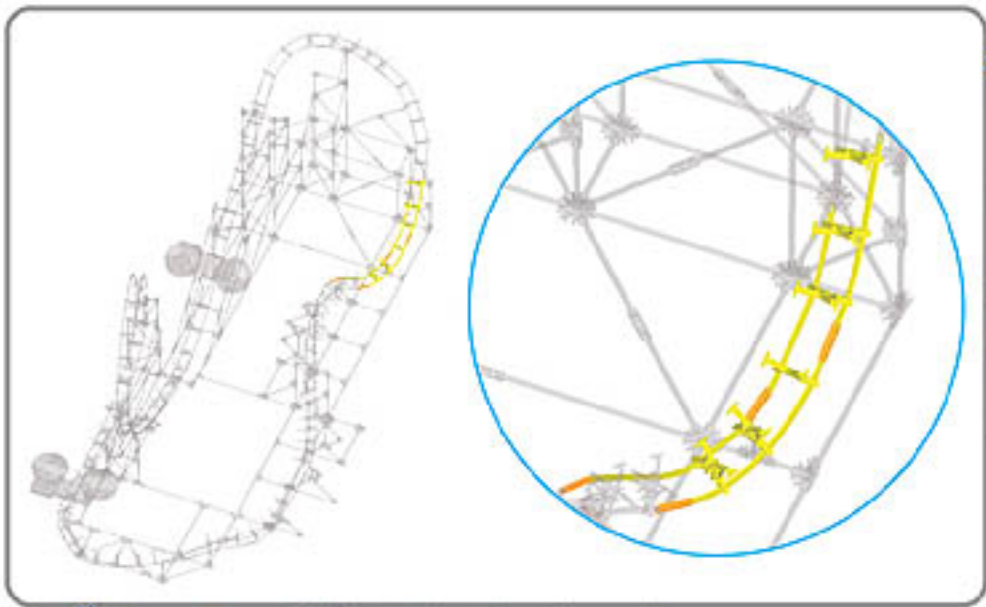

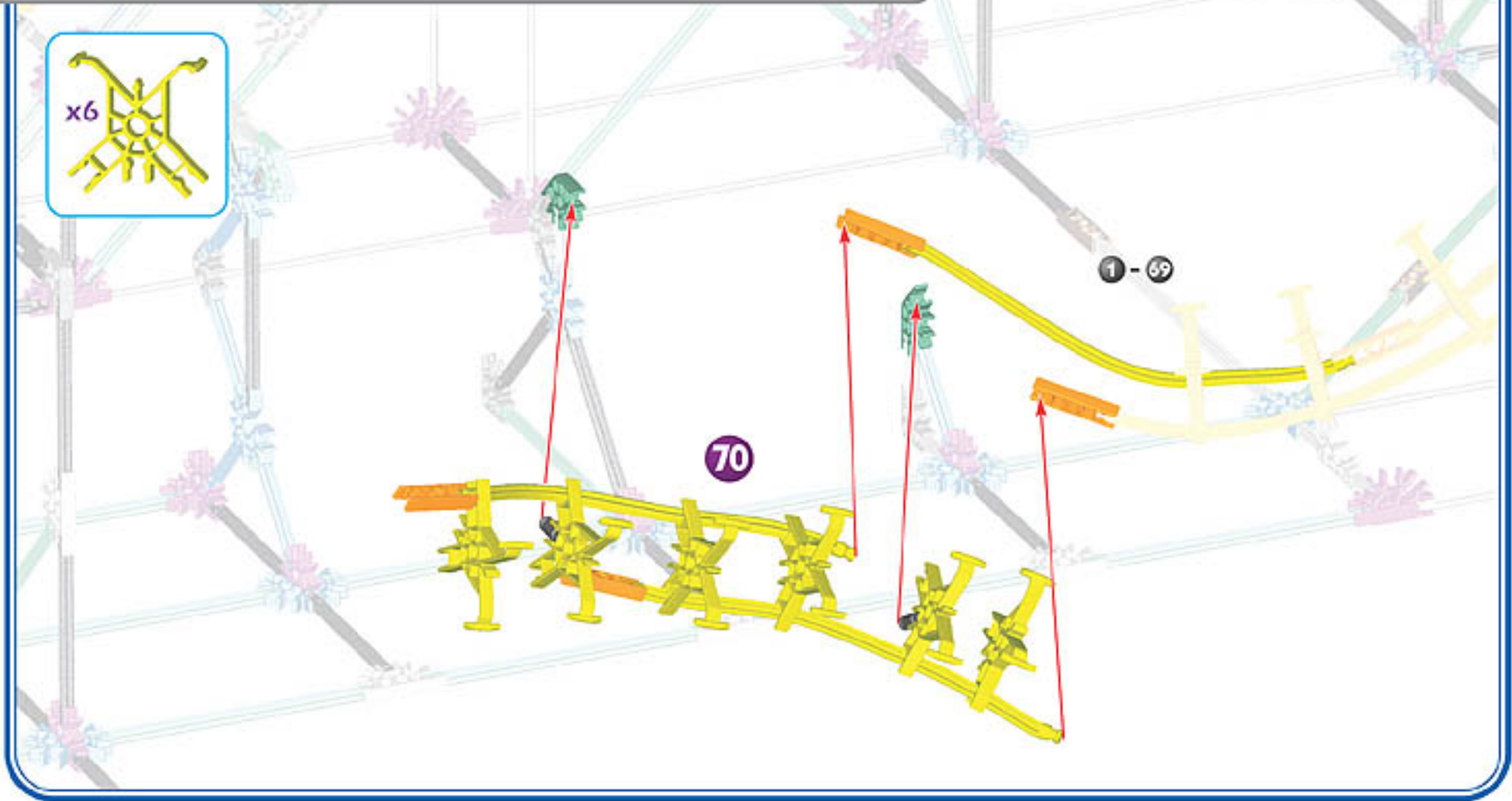
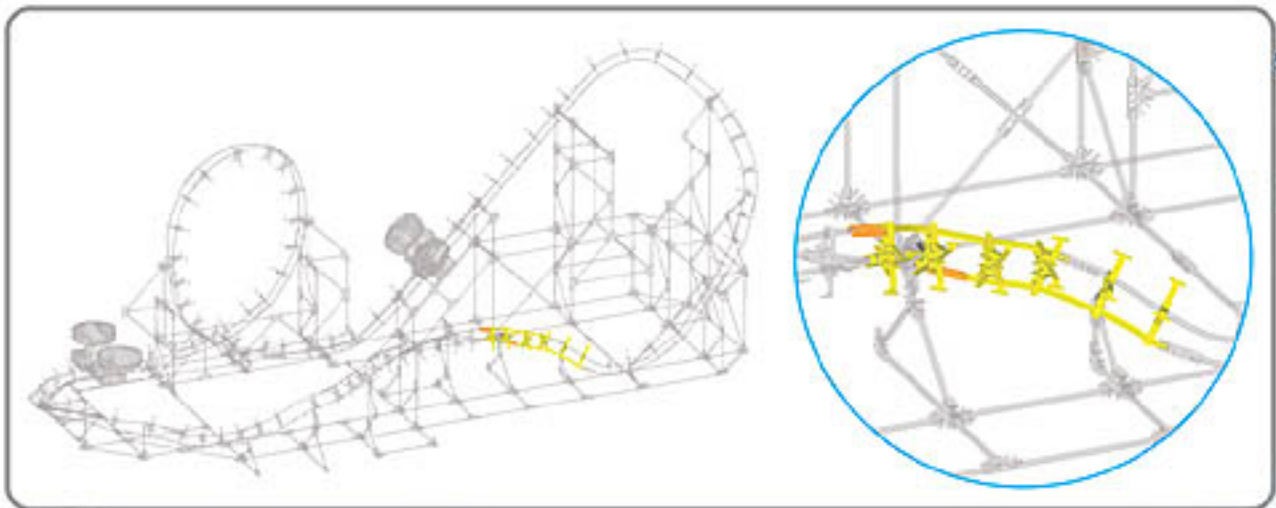

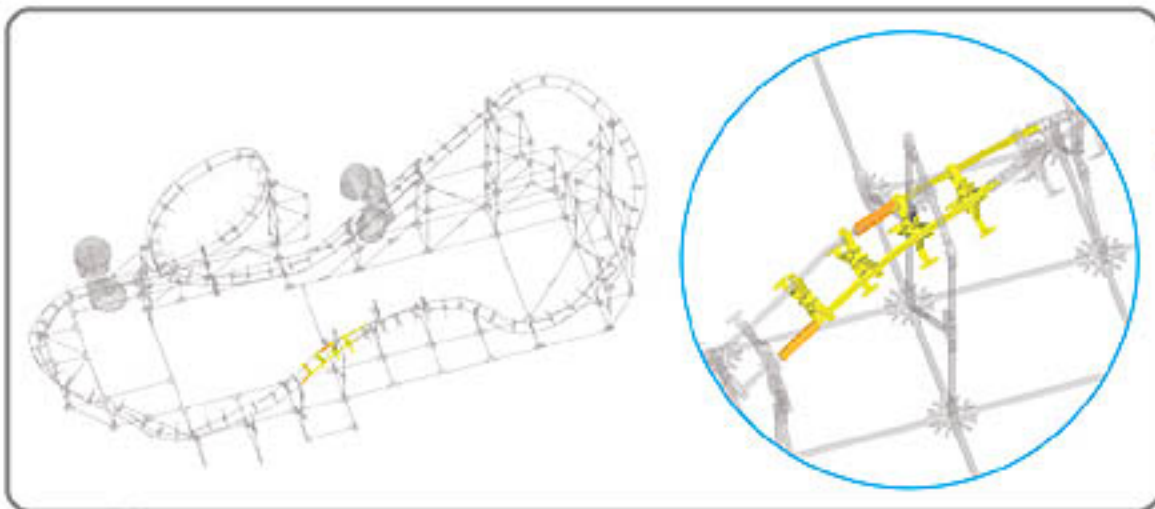

x4

Turn these Track Connectors upside down before attaching to the Rods.

72

1-71



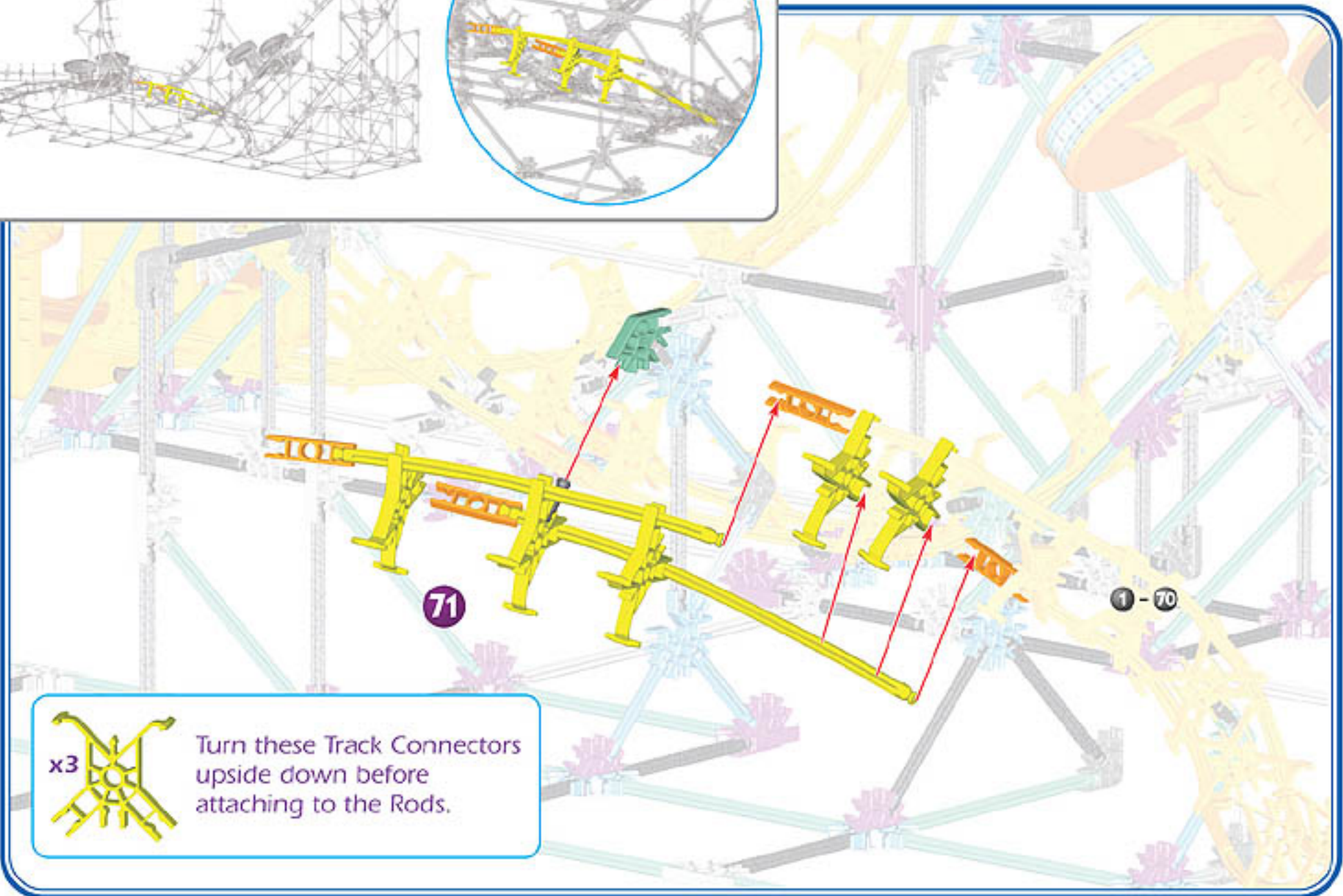
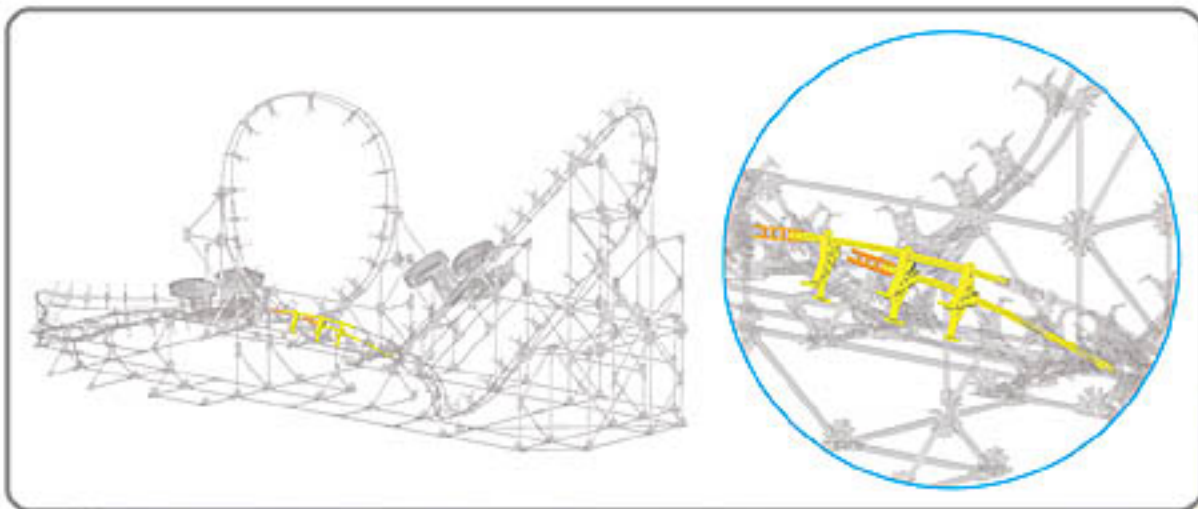

x3

Turn these Track Connectors upside down before attaching to the Rods.



x4

73

1 - 72

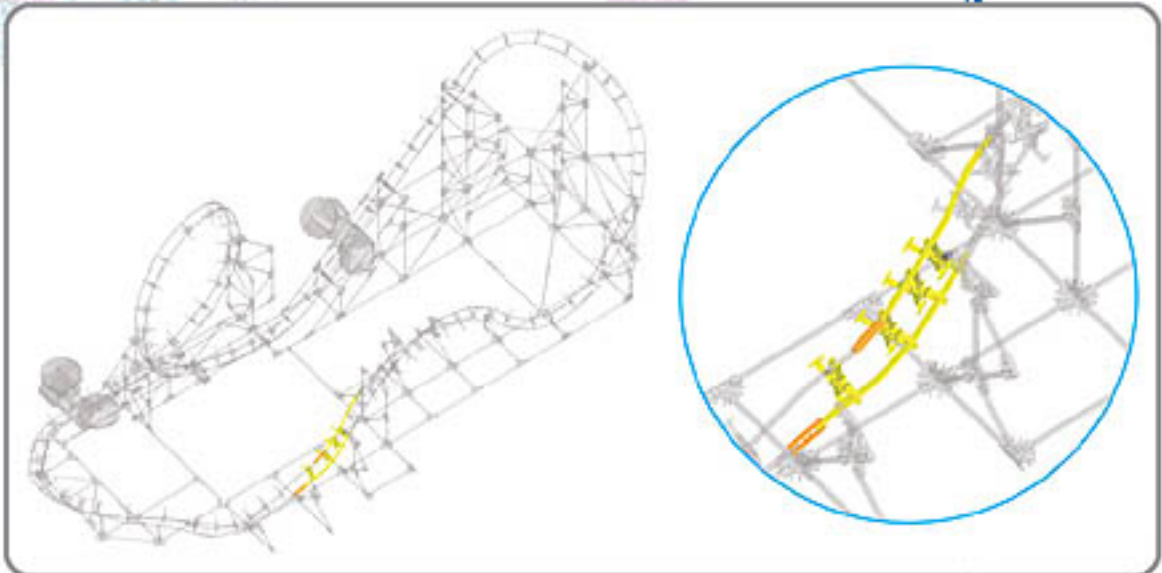

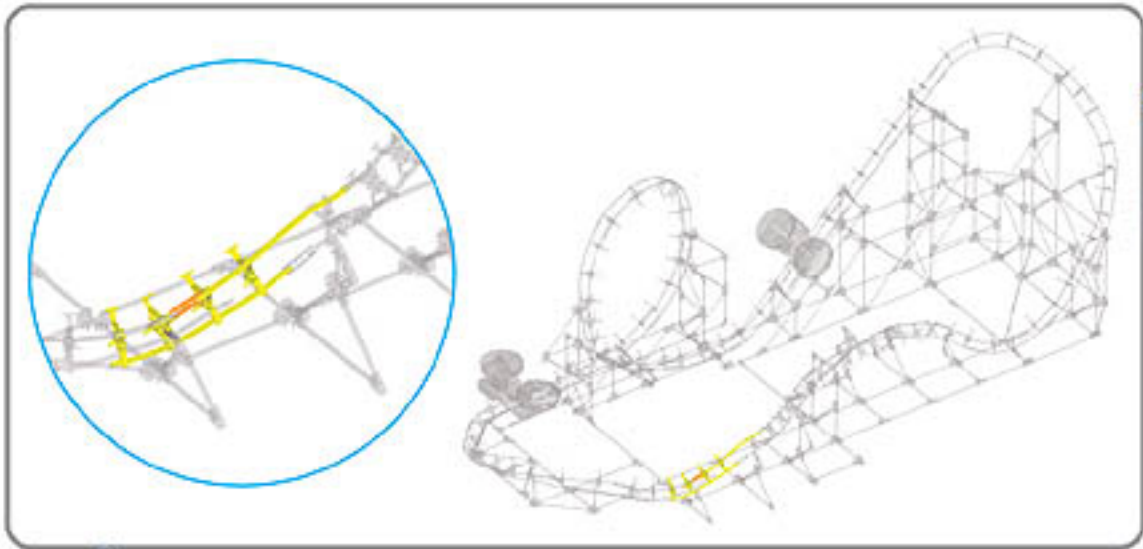

74

1-73

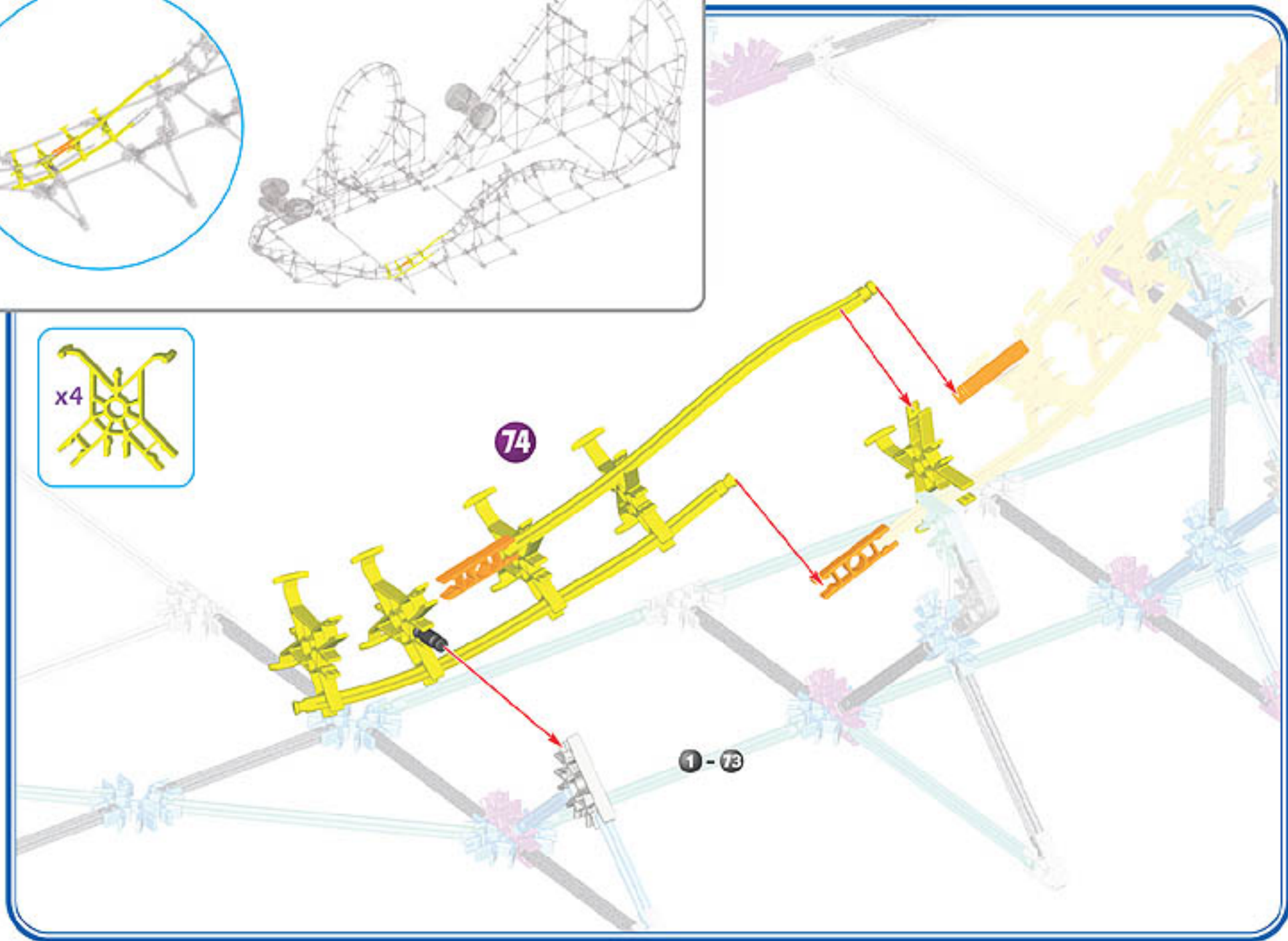

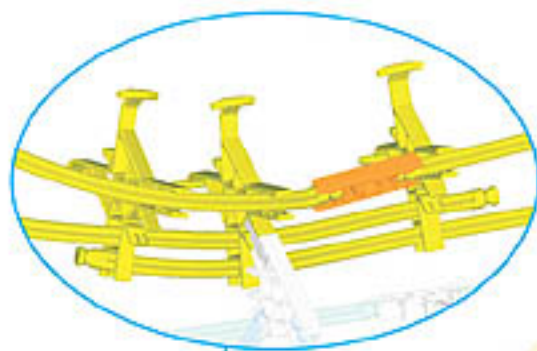
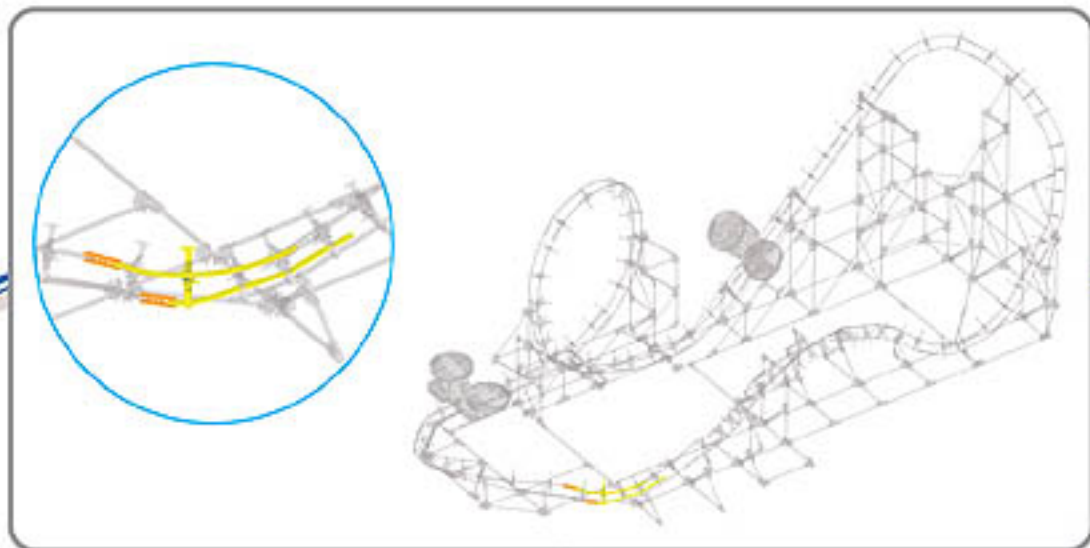

Rod goes through the square hole in these Track Connectors.



Now it's time to put on both sides of the Track!

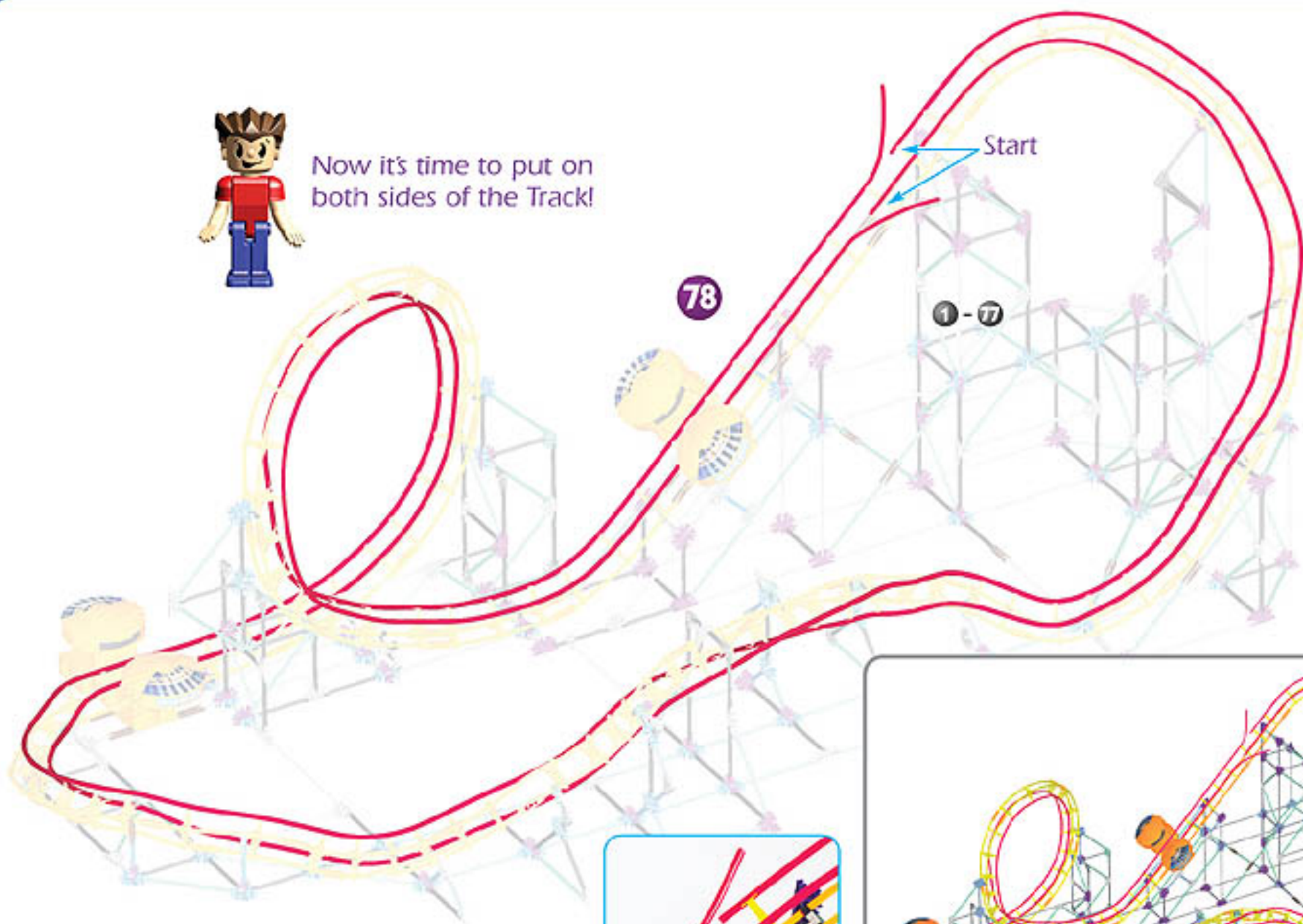

Don't cut Track yet.

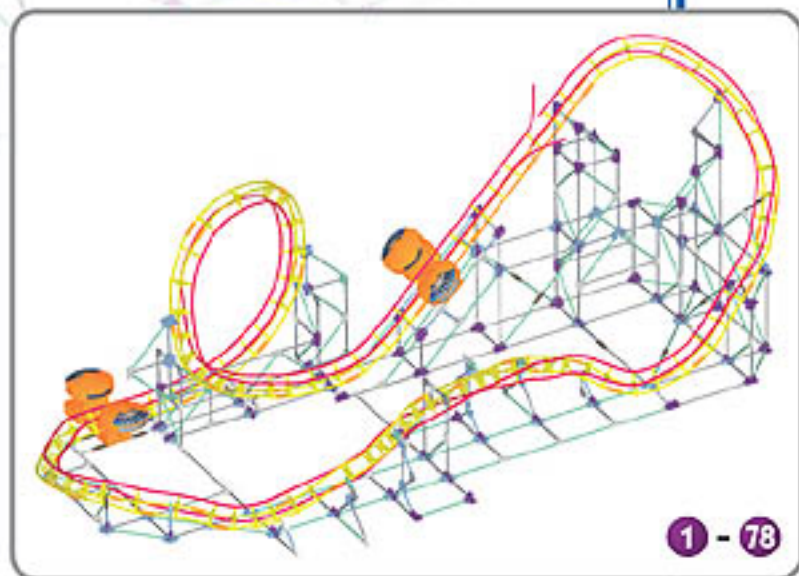

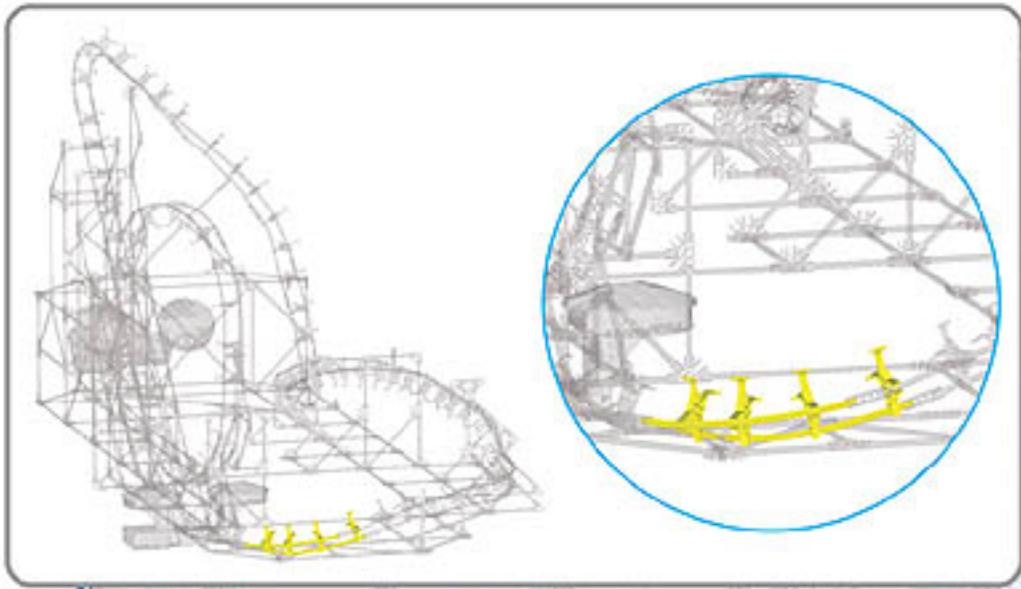

77

1-76

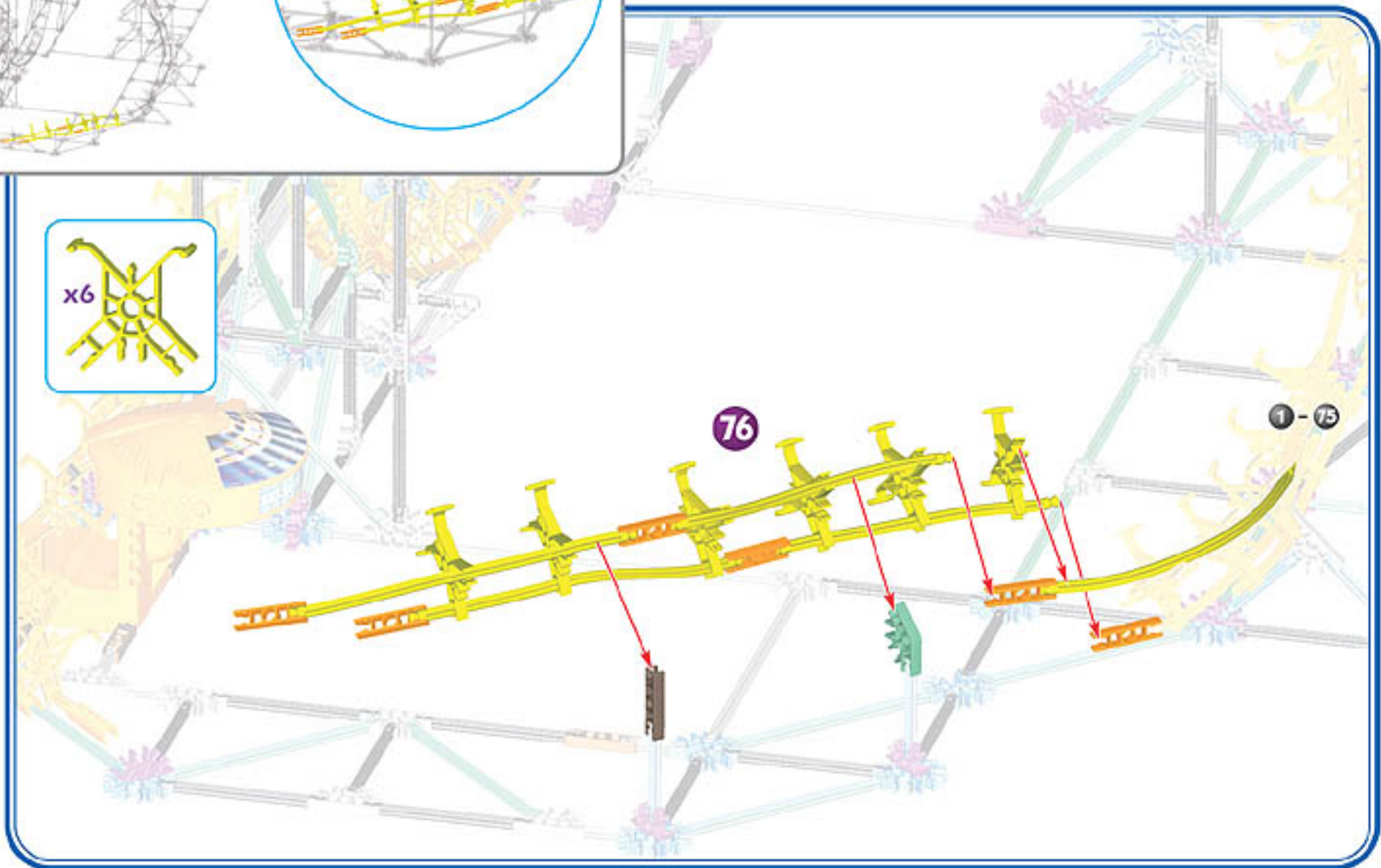
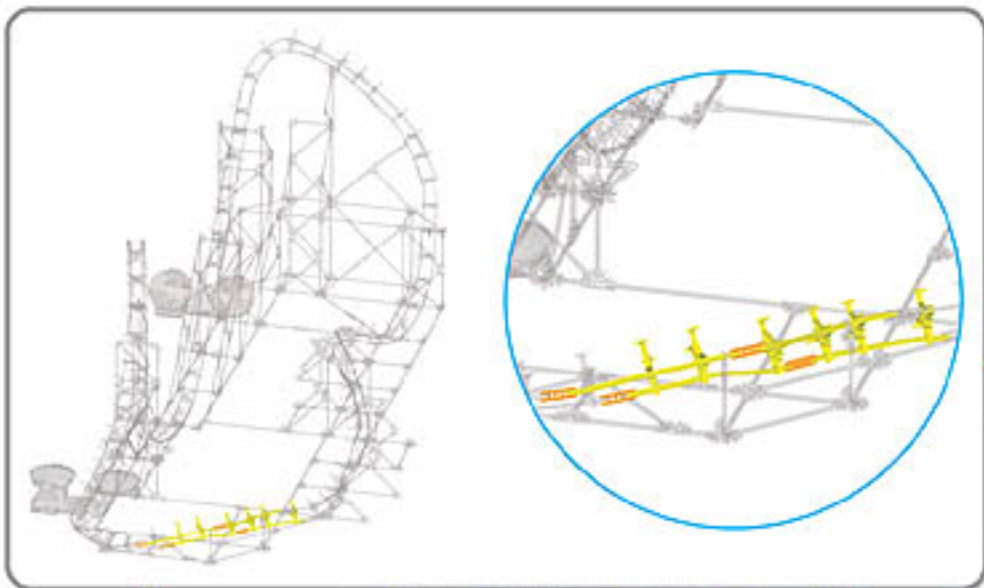

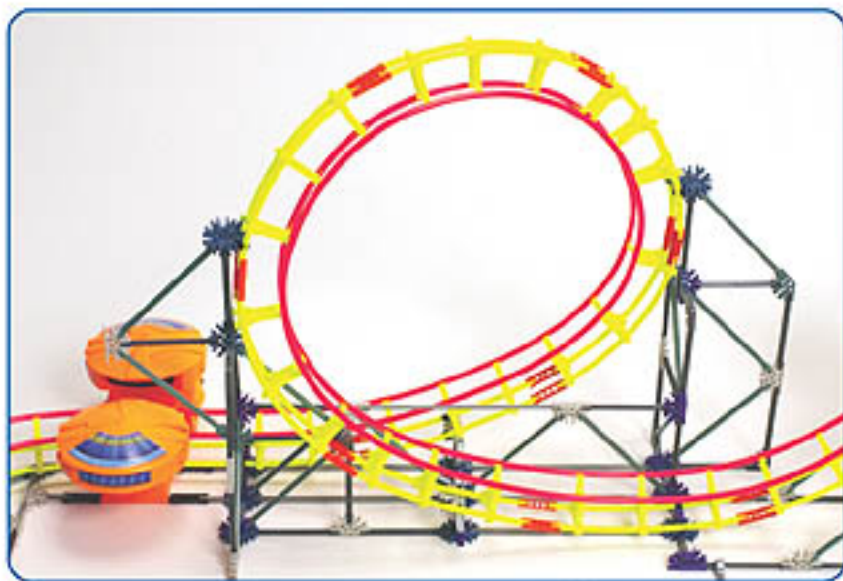

It's important to smooth out the Track, especially in the loop area, before you finally cut the Track.



To attach rocket car, squeeze the Track together and put one side of the car on first, then the other side.



Use sharp scissors to cut the Track as shown.
(Adult help is recommended)

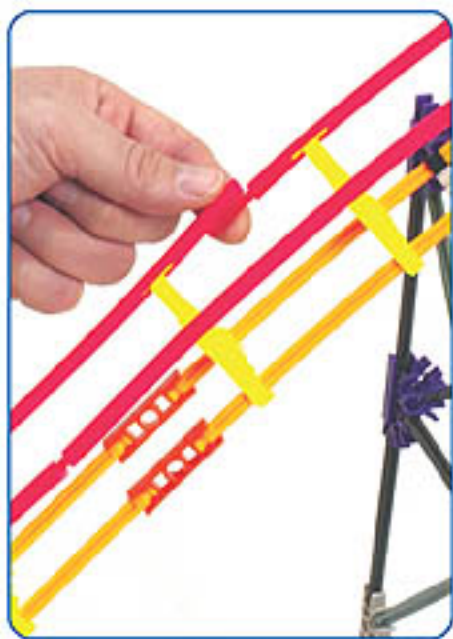

Use a splicer to connect the ends of the track.

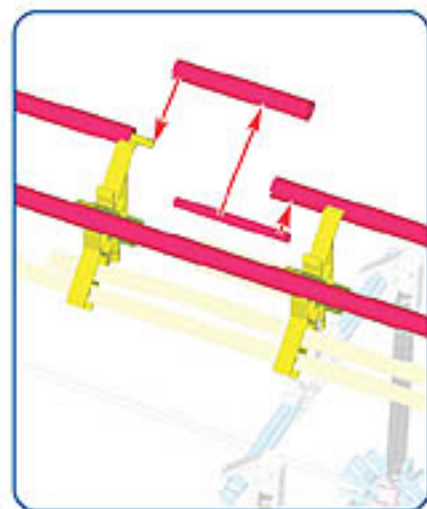

If you cut the Track too short, cut a little more off and then cut a filler piece of Track and splice them together.